



**James Thomas
Engineering**

Evolution --- of Tradition ---

Our story	4
<hr/>	
Policies	6
<hr/>	
Truss	8
<hr/>	
General Purpose Truss 12 × 12	10
General Purpose Truss 18 × 12	11
General Purpose 12" Triangle	12
General Purpose 20.5" Triangle	13
General Purpose Truss 15 × 15	14
General Purpose 20.5 × 20.5	16
Single Bar Pre-Rig	18
General Purpose HD 20.5 × 30	20
Pre-Rig Truss	22
Moving Light Truss	24
<hr/>	
Ladders	26
<hr/>	
General Purpose 12" Ladder	28
General Purpose 20.5" Ladder	29
SuperTruss 12" Ladder	30
SuperTruss 20.5" Ladder	31
<hr/>	
SuperTruss	32
<hr/>	
SuperTruss 12 × 12	34
SuperTruss 15 × 15	35
SuperTruss 18 × 12	36
SuperTruss 20.5 × 20.5	37
Single Bar Pre-Rig SuperTruss	38
SuperTruss 20.5 × 30	40
Pre-Rig SuperTruss	42
Moving Light SuperTruss	44
20.5" Folding SuperTruss	46
Galaxy 240	48
Galaxy 300	50
<hr/>	
SuperMega Truss	52
<hr/>	
SuperMega Truss 500 × 1000	54
SuperMega Truss & Tower 30 × 30	56
SuperMega Truss 36 × 36	58
Circles And Custom Shapes	60
<hr/>	
Tower Systems	62
<hr/>	
12" Tower System	64
15" Tower System	66
12" SuperTower System	67

15" SuperTower System	68
20.5" SuperTower System	69
SuperMega Tower 30 × 30	70
Tower Accessories	72
Base Plates	74

Audio Towers 76

Mini TAT	78
TAT	80

Rigging Hardware & Truss Accessories 82

ProPlus Fall Arrest Kits	84
Retractable Lifelines	85
Clamps	86
Grab Bars	87
Truss Lifting Points	88
Meat Racks	90
Spot Chairs	91

Roof Systems 92

Hoists & Controllers 96

Hoists CM Prostar series	98
Hoists CM Lodestar series	100
Hoists 2-ton single - reeved	102
EXE technology	104
Hoist controller Skjonberg	106

Crowd Barriers 110

Custom Projects 118

Truss Inspection 130

Truss Usage and Guidelines 133

OUR STORY

James Thomas Engineering was born in a small garage in Bishampton England in 1977. From those humble beginnings, to a converted office unit, to a much larger 5,000 square foot unit in 1980, the seeds were planted for a new industry leader in aluminum general purpose truss design.



By 1983, James Thomas developed a pre-rigged truss design used by major rock bands on world tours. Fast forward to 1990, When James Thomas Engineering began manufacturing in the United States to keep truss design moving on both sides of the Atlantic Ocean. In 1992, the supertruss system was designed. This new truss design proved that James Thomas Engineering was on the leading edge of aluminum and general purpose truss design. As the years passed, James Thomas Engineering continued to grow. As demand for supertruss systems grew, and with creation of newer products, the need for a new facility was created. In October of 2001, the office in the United States relocated to a new 30,000 foot facility specifically built on 6.5 acres. By growing with their demands, they continued to maintain the exceptional customer service Thomas clients

had come to expect. As an industry leader in supertruss systems and general purpose aluminum truss design, James Thomas Engineering was committed to their mission statement: Innovation through design and excellence. In 2014, James Thomas partnered with TOMCAT and Area Four Industries to be a part of the world's largest group of aluminum truss manufacturers. With this collaboration, James Thomas Engineering continues to provide exceptional products and services the market expects. All James Thomas Engineering products shipped in the US are fabricated in the United States by AWS certified welders and must pass rigorous inspection before exiting the facility, ensuring customers receive the high quality products they've come to rely on.



South Bend River Lights
by Rob Shakespeare

POLICIES

CREDIT POLICY

It is the policy of TOMCAT and James Thomas Engineering (herein after referred to as "JTE") that payment be received with the order unless other arrangements have been made, such as cash on delivery. Credit will only be extended to those clients who have successfully completed a credit application, signed a purchase agreement, or otherwise established credit with JTE. Down payments may be required from customers (including those with credit approval) for custom products or other situations that require special raw material purchases or engineering. In such cases, the ordering of materials and fabrication will not proceed until payment or a letter of credit has been received.

SHIPPING POLICY

All shipments are "Ex-works" at the geographic location where the order is placed and shall be in good order upon release to the carrier. All claims for damage or loss in transit must be filed by the consignee against the carrier. All freight should be checked for quantity against bill provided by the carrier. Shipments should be inspected by removing all packaging and checking the truss for damage to chords, internals or to the end of tubes before signing the carrier's receipt. Damage noted on the freight bill will enable the consignee to file a claim against the carrier. Any transport insurance is the responsibility of the purchaser. JTE will not be held responsible or liable for damage, loss or delay in transit.

PRODUCT GUARANTEE

JTE guarantees its products will be free from defects in workmanship and materials at the time of purchase, providing the purchaser follows the manufacturer's guidelines for use. The product will be guaranteed for a period of one year from the date of shipment to perform according to the published product specifications. JTE is not responsible for damage to the product during transit, nor in cases where load specifications were exceeded or where guidelines for usage were not followed.

Except as expressly stated and warranted herein: (i) JTE disclaims any other warranties, whether expressed or implied, including any warranty of merchantability or fitness for a specific purpose; (ii) unless project engineer reports are included, JTE has made no affirmations of fact or promise relating to the goods being sold that has become the basis of this bargain, or that has created or amounted to an express warranty that the goods would conform to any such affirmation or promise; (iii) this warranty extends exclusively to the original purchaser of the warranted goods and subsequent purchasers are not covered by this warranty; (iv) this warranty does not apply to a part which the buyer misuses, damages, improperly maintains, repairs, or replaces with a part not of JTE's manufacture; and (v) except for its duty to repair or replace defective parts, JTE shall not be liable for any consequential or incidental damages resulting from a defective part.

JTE reserves the right to change materials or design, when, in our opinion, such changes will improve the product. This warranty is performed in the geographic location where the originating order was placed and all obligations, rights, and duties of the buyer and JTE shall be governed by the laws of that same geographic location.

RETURN POLICY

Prior to returning any item purchased from JTE, a customer must first contact JTE to obtain a Returned Goods Authorization number (RGA no.). Returned goods without prior authorization will not be accepted. JTE will not generally pay the cost of return freight, and reserves the right to refuse return shipments where the freight has not been prepaid by the returning party.





Truss

James Thomas truss is manufactured by AWS certified welders. All truss is easy to assemble and can accommodate a multitude of lighting fixtures, speaker arrays, video panels, and more. Available in a variety of sizes, James Thomas truss is ideal for applications both indoor and out where strength and reliability are key priorities.



GENERAL PURPOSE TRUSS 12 x 12

12" x 12" General Purpose truss is manufactured from 2" dia x 0.125" wall and 1" dia x 0.125" wall 6082T6 or 6061T6 aluminum tubing. Bolts are supplied for assembly of truss elements. This truss is ideal for conference, exhibition, and small venue work. By incorporating suitable sleeve blocks and towers, this truss can be used with our Ground Support System.



Standard lengths and weights

PRODUCT CODE	DESCRIPTION	WT lbs
B0700	10' Section	55
B0701	8' Section	46
B0702	5' Section	35
B0703	2' 6" Section	24

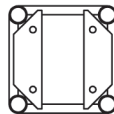

End View

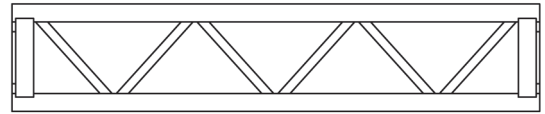

Side View



Lifting Point

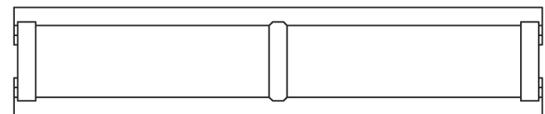

Plan View

Corners

PRODUCT CODE	DESCRIPTION	WT lbs
B4705	2 Way Corner Block	15
B4705A	3 Way Corner Block	17.5
B4706	4 Way Corner Block	19.5
B4706A	5 Way Corner Block	25.9
B4707	6 Way Corner Block	26.5
B4708	Flat Plate Hinge Section	14

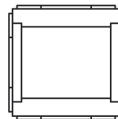

4 Way

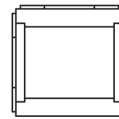

3 Way

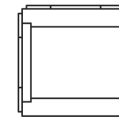

2 Way

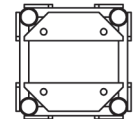

6 Way

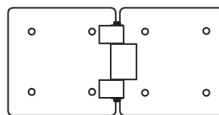

Flat Pivot Section

Loading chart

Allowable Load Data	Maximum Allowable Uniform Loads		Maximum Allowable Center Point Loads	
	Span feet	Loads pounds	Maximum deflection inches	Loads pounds
10	6140	0.276	4497	0.315
20	3100	1.10	1550	1.10
30	1726	2.21	864	2.21
40	855	2.96	428	2.96

LOADING FIGURES show maximum loads between supports in addition to the self weight of the truss. Information extracted from the structural report by Broadhurst, Goodwin, and Dunn for Truss manufactured after November 1993. * denotes load limited to suit maximum shear capacity. All loads include 20% overload factor for dynamic effects.

GENERAL PURPOSE TRUSS 18 × 12

18" x 12" manufactured the same way as 12" x 12", but has an added advantage due to its width of 18", of being able to accommodate 2 lighting bars back to back. The truss is also slightly stronger over longer spans. It is made from 6061T6 or 6082T6 alloy 2" x 0.125" tubes for the main chords and 1" x 0.125" tubes for the diagonals. The truss can be used with Ground Support System with suitable sleeve blocks.



Standard lengths and weights

PRODUCT CODE	DESCRIPTION	WT lbs
B0600	10' Section	61.5
B0601	8' Section	52.5
B0602	5' Section	37.5
B0603	2' 6" Section	24

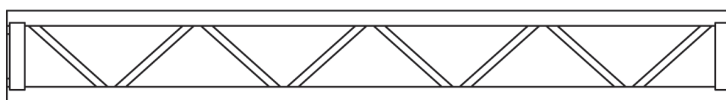

Side View

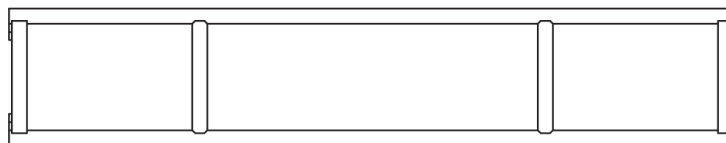

Plan View

Corners

PRODUCT CODE	DESCRIPTION	WT lbs
B4608	4 Way Corner Block	22
B4609	5 Way Corner Block	25.5
B4610	6 Way Corner Block	29

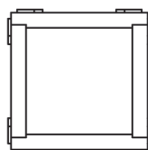

4 Way

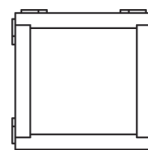

3 Way

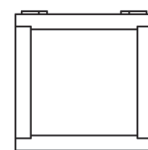

2 Way

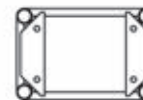

End View

Loading chart

Allowable Load Data	Maximum Allowable Uniform Loads		Maximum Allowable Center Point Loads	
	Span feet	Loads pounds	Maximum deflection inches	Loads pounds
10	6140	0.276	4497	0.20
20	3100	1.10	1550	1.10
30	1726	2.20	864	2.20
40	855	2.95	427	2.95
50	425	3.70	214	3.70

LOADING FIGURES show maximum loads between supports in addition to the self weight of the truss. Information extracted from the structural report by Broadhurst, Goodwin, and Dunn for Truss manufactured after November 1993. * denotes load limited to suit maximum shear capacity. All loads include 20% overload factor for dynamic effects.

GENERAL PURPOSE 12" TRIANGLE

12" x 60° equilateral triangular truss is designed and manufactured for high strength, in relation to storage space required. The main chords are 2" x 0.125" tube and the diagonals are 1" x 0.125" tube in either 6082T6 or 6061T6. The truss can be used with a Ground Support System with appropriate Sleeve Blocks and Towers. Each section is complete with bolts.



Standard lengths and weights

PRODUCT CODE	DESCRIPTION	WT lbs
B9120	10' section	45
B9096	8' section	35
B9060	5' section	25
B9030	2.5' section	18

Corners

PRODUCT CODE	DESCRIPTION	WT lbs
B9002	2 way corner block	13
B9003	3 way corner block	18
B9004	4 way corner block	23
B9008	Flat pivot section	17

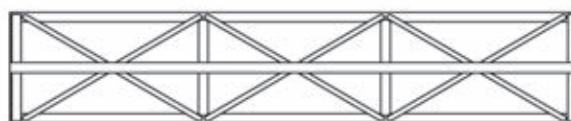

Plan View



End View

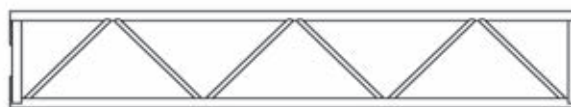

Side View



4 Way



3 Way

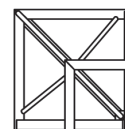

2 Way

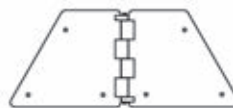

Flat Pivot Section
0-180°

Loading chart

Allowable Load Data	Maximum Allowable Uniform Loads		Maximum Allowable Center Point Loads		
	Span feet	Loads pounds	Maximum deflection inches	Loads pounds	Maximum deflection inches
10		5000	0.41	2500	0.41
20		2300*	1.50	1450	1.50
30		1030*	2.25	650	2.25
40		580*	3.00	360	3.00

LOADING FIGURES show maximum loads between supports in addition to self weight of truss. Information extracted from structural report by Jessie Mise. + Denotes load limited to suit maximum shear capacity. *Denotes load limited to a maximum deflection of (span/160). All loads include a 20% overload factor for dynamic effects.

GENERAL PURPOSE 20.5" TRIANGLE

23 1/4" x 60° equilateral triangular truss is designed and manufactured for high strength, in relation to storage space required. The main chords are 2" x 0.125" tube and the diagonals are 1" x 0.125" tube in either 6082T6 or 6061T6. The truss can be used with a Ground Support System with appropriate Sleeve Blocks and Towers. Each section is complete with bolts.



Standard lengths and weights

PRODUCT CODE	DESCRIPTION	WT lbs
B0500	10' section	66
B0501	8' section	53
B0502	5' section	35

Corners

PRODUCT CODE	DESCRIPTION	WT lbs
B4505	2 way corner block	35
B4506	3 way corner block	39.5
B4507	4 way corner block	44
B4508	Flat pivot section	39.5

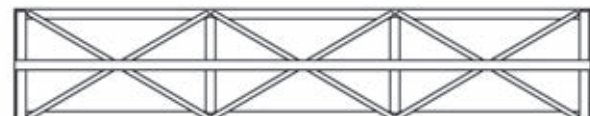

Plan View



End View

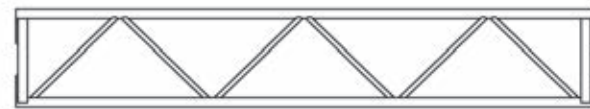

Side View

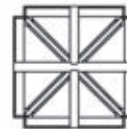

4 Way

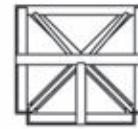

3 Way

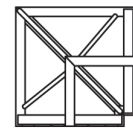

2 Way

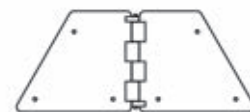

Flat Pivot Section
0-180°

Loading chart

Allowable Load Data Span feet	Maximum Allowable Uniform Loads		Maximum Allowable Center Point Loads	
	Loads pounds	Maximum deflection inches	Loads pounds	Maximum deflection inches
10	5600	0.1	2800	0.1
15	5600	0.34	2800	0.34
20	4700	0.70	2350	0.70
25	3700	1.09	1850	1.09
30	3000	1.57	1500	1.57
40	2100	2.8	1050	2.8
50	1300	3.75	650	3.75
60	700	4.50	350	4.50

LOADING FIGURES show maximum loads between supports in addition to self weight of truss. Information extracted from structural report by Jessie Mise. + Denotes load limited to suit maximum shear capacity. *Denotes load limited to a maximum deflection of (span /160). All loads include a 20% overload factor for dynamic effects.

GENERAL PURPOSE TRUSS 15 x 15

15" x 15" General Purpose truss is manufactured from 2" dia x 0.125" wall and 1" dia x 0.125" wall 6082T6 or 6061T6 aluminum tubing. Bolts are supplied for assembly of truss elements. This truss is ideal for conference, exhibition, and small venue work. By incorporating suitable sleeve blocks and towers, this truss can be used with our Ground Support Systems.



Standard lengths and weights

PRODUCT CODE	DESCRIPTION	WT lbs
B1510	10' Section	61.5
B1508	8' Section	53
B1505	5' Section	39.5
B1525	2' 6" Section	27.5

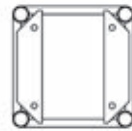

End View

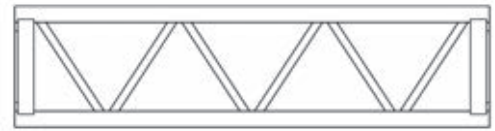

Side View



6 Way

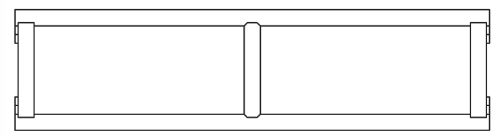

Plan View

Corners

PRODUCT CODE	DESCRIPTION	WT lbs
B1502	2 Way Corner Block	18.5
B1503	3 Way Corner Block	21
B1504	4 Way Corner Block	24
B1506	6 Way Corner Block	28.5
B1507	Flat Plate Hinge Section	20

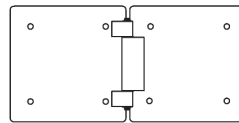

Flat Pivot Section

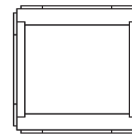

4 Way

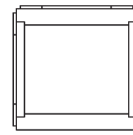

3 Way

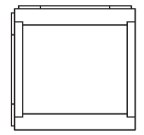

2 Way

Loading chart

Allowable Load Data Span feet	Maximum Allowable Uniform Loads		Maximum Allowable Center Point Loads	
	Loads pounds	Maximum deflection inches	Loads pounds	Maximum deflection inches
10	9200	0.17	4600	0.17
15	6100	0.38	3050	0.38
20	4500	0.67	2250	0.67
25	3500	1.04	1750	1.04
30	2900	1.50	1450	1.50
40	2000	2.67	1000	2.67
50	1300*	3.75	650*	3.75
55	1000*	4.13	500*	4.13

LOADING FIGURES show maximum loads between supports in addition to self weight of truss. Information extracted from structural report by Jessie Mise. *Denotes load limited to a maximum deflection of (span /160). All loads include a 20% overload factor for dynamic effects.



GENERAL PURPOSE 20.5 × 20.5

20.5" x 20.5" General Purpose truss manufactured from 6061T6 or 6082T6 aluminum using 2" x 0.125" wall and 1" x 0.125" wall tubes. It is supplied as standard with bolts for connection. GP 20.5" x 20.5" is suitable for the majority of lighting applications, flying P.A. and any general purpose use. It can be used with a Ground Support System by incorporating suitable sleeve blocks and towers. This truss can also be supplied with castor wheels.



Standard lengths and weights

PRODUCT CODE	DESCRIPTION	WT lbs
B0400	10' Section	88
B0401	8' Section	75
B0402	5' Section	60

Standard lengths and weights

PRODUCT CODE	TRUSS WITH CASTERS	WT lbs
B0420	10' Section	105
B0421	8' Section	92
B0422	5' Section	77

Corners

PRODUCT CODE	DESCRIPTION	WT lbs
B4407	4 Way Corner Block	37
B4407A	5 Way Corner Block	40
B4408	6 Way Corner Block	42
B4409	Universal pivot section 0 - 270 degree	43
B4410	Universal pivot section 0 - 90 degree	42
B4411	Flat pivot section 0 - 180 degree	37
B4412	G.P. to triangular adapter	-
B4413	G.P. to 12" adapter	-



10 ft Truss



Bottom View



End View

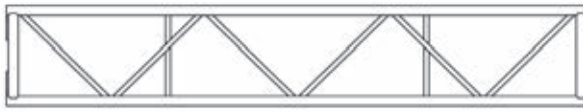

Front View

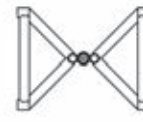
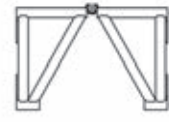
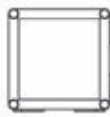
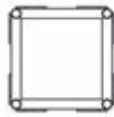
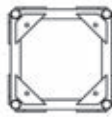
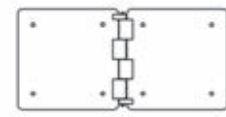
 Universal Pivot Section
90-0-90°

 Universal Pivot Section
0-270°

 2 Way
Corner
Block

 4 Way
Corner
Block

 6 Way
Corner
Block

 Flat Pivot Section
0-180°

Loading chart

Allowable Load Data	Maximum Allowable Uniform Loads		Maximum Allowable Center Point Loads	
	Span feet	Loads pounds	Maximum deflection inches	Loads pounds
10	5741	1.06	2870	1.06
20	5741	1.06	2870	1.06
30	3715	1.57	1858	1.57
40	2643	2.44	1322	2.44
50	1911	3.70	957	3.70

LOADING FIGURES show maximum loads between supports in addition to the self weight of the truss. Information extracted from the structural report by Broadhurst, Goodwin, and Dunn for Truss manufactured after November 1993. * denotes load limited to suit maximum shear capacity. All loads include 20% overload factor for dynamic effects.

SINGLE BAR PRE-RIG

A revolutionary truss designed to offer all the advantages of the regular Pre-rigged in a Single bar Pre-Rig layout. The size is 20.5" wide x 20.5" deep x 96" long as standard. The truss features a guide rod. This truss allows the use of pre-rig lighting bars with short nose Par lanterns. Ideal for users where a small truck pack is required.



Standard lengths and weights

PRODUCT CODE	DESCRIPTION	WT lbs
B0420S4	10' section	65
B0421S4	8' section	45
	See GP 20.5" x 20.5" cut sheet for other accessories	

To lower lanterns from storage to operating position, simply pull tab on shank hook with one hand while holding the lighting bar with the other hand. Then lower the lanterns into operating position.

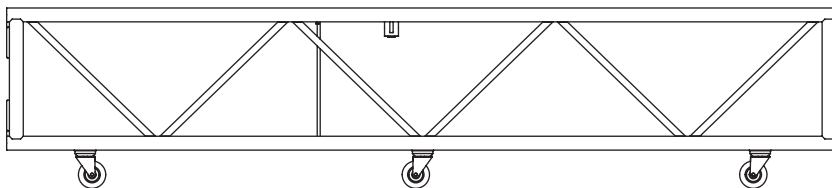
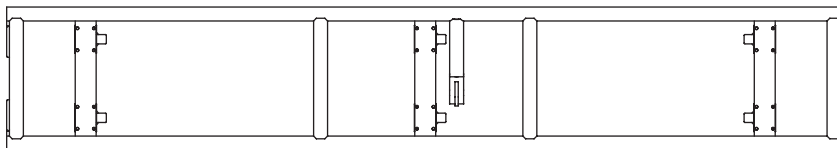
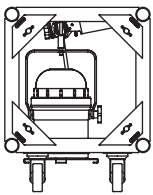

Thomas Pre-rigged Truss is designed to carry two lighting bars complete with lanterns. The loaded bars can be stored internally in the truss and lowered into working position during shows, making PRT a great choice for complete roof systems.

GENERAL PURPOSE HD 20.5 × 30

20.5" x 30" truss is for those ever increasing load requirement situations. The truss is connected together with bolts as standard and can be used with a Ground Support System by using suitable Sleeve Blocks and Towers. This truss can also be specified with caster wheels. The main chords of the truss are made from 2" x 0.125" and the diagonals are 1" x 0.125". Aluminum Alloys are either 6061T6 or 6082T6.

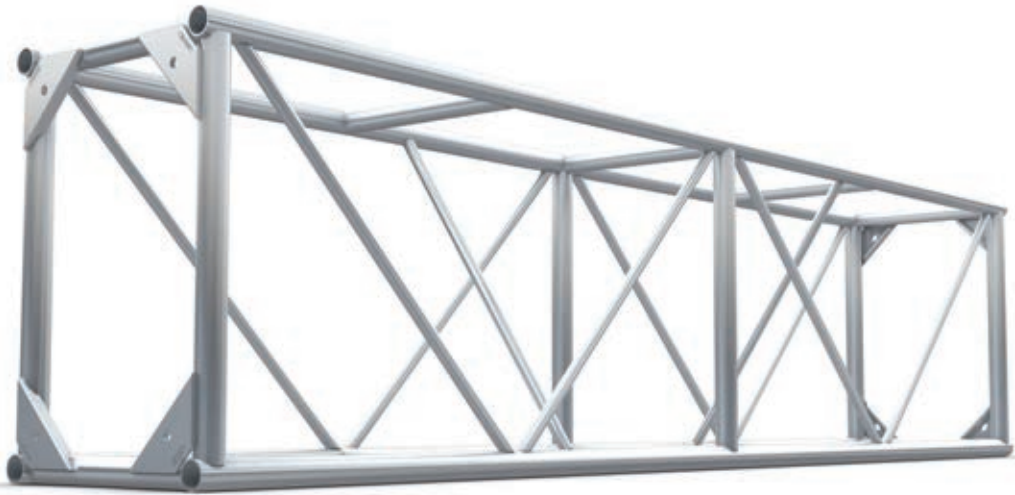

Standard lengths and weights

PRODUCT CODE	DESCRIPTION	WT lbs
B0900	10' section	79.5
B0901	8' section	72.5
B0902	5' section	66

Standard lengths and weights

PRODUCT CODE	TRUSS WITH CASTERS	WT lbs
B0920	10' section	97
B0921	8' section	90
B0922	5' section	83.5

Corners

PRODUCT CODE	DESCRIPTION	WT lbs
B4906	2 way corner block	35
B4907	3 way corner block	37.5
B4908	4 way corner block	40

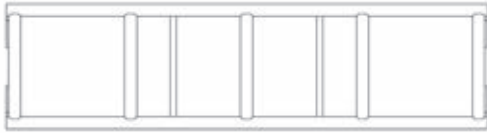

Plan View



End View



Side View



Plan View



End View

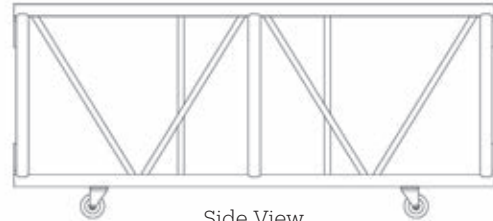

Side View

Loading chart

Allowable Load Data Span feet	Maximum Allowable Uniform Loads		Maximum Allowable Center Point Loads	
	Loads pounds	Maximum deflection inches	Loads pounds	Maximum deflection inches
10	5646*	0.236	5646*	0.315
20	5646*	0.236	5646	0.315
30	5562*	0.709	4202	0.709
40	4127	1.65	2063	1.65
50	3150	2.05	1574	2.05
60	2460	2.80	1230	2.80
70	1953	3.66	976	3.66

LOADING FIGURES show maximum loads between supports in addition to self weight of truss. Information extracted from structural report by Broadhurst, Goodwin & Dunn for truss manufactured after November 1993. * Denotes load limited to suit maximum shear capacity. All loads include 20% overload factor for dynamic effects.

PRE-RIG TRUSS

Pre-Rig truss is 30" x 26" in size. It is manufactured from aluminum tube 6082-T6 with 2" x .125" wall thickness for main tubes and 1" x .125" wall tube for the diagonals. Each truss piece has 4 caster wheels for easy maneuverability and bolts for the connection of truss pieces.

Each truss is designed to carry 2 lighting bars complete with lanterns. The lighting bars are stored internally in the truss and can be lowered to the working position when in use. This design reduces the amount of space required for lighting and rigging in the truck. Each truss is also designed to carry a varying amount of lanterns. The 10' section carries 2 bars of 8 lanterns, 7' section carries 2 bars of 6 lanterns, 5' section carries 2 bars of 4 lanterns, and the 3' 9-1/2" section carries 2 bars of 3 lanterns. This feature enables great flexibility in the truss design.

The Pre-Rig truss accepts a modified lighting bar which have 2 sleeved holes in them. The lighting bars are located inside the truss by guide rods. In the storage position the bars are securely held in the truss by shank hooks. The whole system can be used with our Ground Support System by using suitable sleeve blocks and towers.



Standard lengths and weights

PRODUCT CODE	DESCRIPTION	WT lbs
B0300	10' section (empty)	111.3
B0301	7' 7" section (empty)	91
B0302	5' section (empty)	77.15
B0303	3' 9 1/2" section (empty)	57.35
B0304	6"-12" make up piece (empty)	-

Corners

PRODUCT CODE	DESCRIPTION	WT lbs
B4300	2 way corner block	52.9
B4301	4 way corner block	61.75

To lower lanterns from storage to operating position, simply pull tab on shank hook with one hand while holding the lighting bar with the other hand. Then lower the lanterns into operating position.

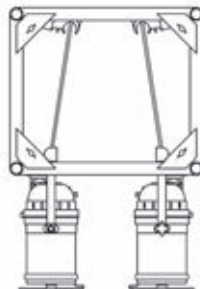

Standard lengths and weights

PRODUCT CODE	DESCRIPTION	WT lbs
B4302	Universal pivot section 0-270 degree	59.5
B4303	Universal pivot section 0-90 degree	59.5
B4304	Horizontal load-bearing pivot section	123.5
B4305	Vertical load-bearing pivot section	123.5
B4306	P.R.T. to G.P. adapter	28.65

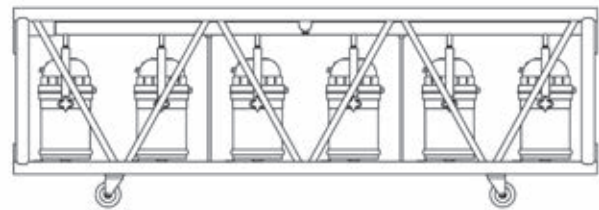

Par 64 lanterns in storage position

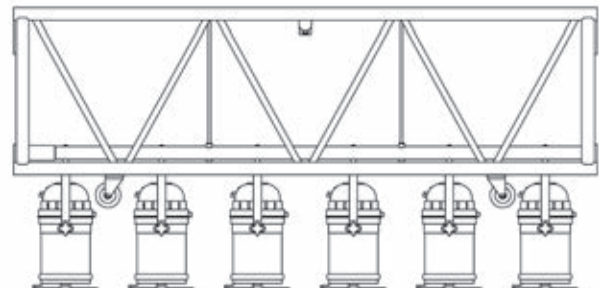

Par 64 lanterns lowered to operating position

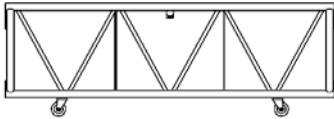
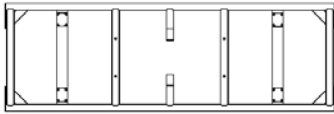

7' 7" Pre-Rig Truss

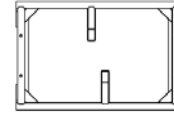
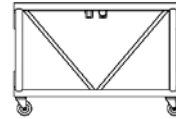
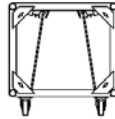

3' 9 1/2" Pre-Rig Truss

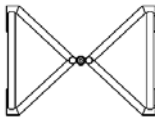

Universal Pivot Section 0-90°

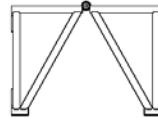

Universal Pivot Section 0-270°

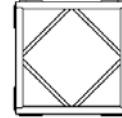

4 Way Corner Block

Loading chart

Allowable Load Data empty Pre-rigged	Maximum Allowable Uniform Loads		Maximum Allowable Center Point Loads	
	Span 7'-7" sections feet	Loads pounds	Maximum deflection inches	Loads pounds
2) 15.17	6980*	0.63	4691	0.945
3) 22.75	6138	1.26	3069	1.26
4) 30.33	4458	1.69	2229	1.69
5) 37.92	3395	2.09	1698	2.09
6) 45.5	2676	2.72	1338	2.72
7) 53.08	2134	3.66	1067	3.66
8) 60.67	1671	4.72	836	4.72

LOADING FIGURES show maximum loads between supports in addition to self weight of truss. Information extracted from structural report by The Broadhurst Partnership. * Denotes load limited to suit maximum shear capacity. All loads include a 20% overload factor for dynamic effects.

MOVING LIGHT TRUSS

Moving Light truss has been designed around the Pre-rigged truss size. 91" x 30" x 26" in size (other sizes) are available. It is manufactured from aluminum tube 6082-T6 with 2" x .125" wall thickness for main tubes and 1" x .125" wall tube for the diagonals. Each truss piece has 8 caster wheels for easy maneuverability and bolts for the connection of truss pieces. Each 91" truss is designed to carry 3 moving light fixtures. The moving lights are stored internally in the truss and can be lowered to the working position when in use. This design reduces the amount of space required for lighting and rigging in the truck. Two handles allow the lowering of each moving light. The whole system can be used with our Ground Support System by using suitable sleeve blocks and towers. Please note: no fixtures are included with truss.



Standard lengths and weights

PRODUCT CODE	DESCRIPTION	WT lbs
MLT-120-R3	10' section (empty)	193**
MLT-91-R3	7' 7" section (empty)	145**
MLT-42-R3	42" section (empty)	97**

Corners

PRODUCT CODE	DESCRIPTION	WT lbs
B4300	2 way corner block	52.9
B4301	4 way corner block	61.75

Truss Accessories

PRODUCT CODE	DESCRIPTION	WT lbs
B4302	Universal pivot section 0-270 degree	59.5
B4303	Universal pivot section 0-90 degree	59.5
B4304	Horizontal load-bearing pivot section	123.5
B4305	Vertical load-bearing pivot section	123.5
B4306	P.R.T. to G.P. Adapter	28.65
	**all weights subject to correction	

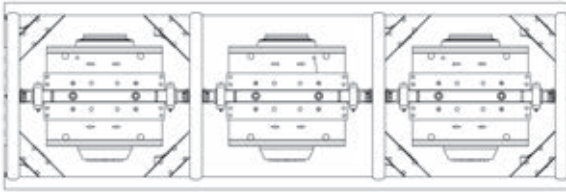

Plan View

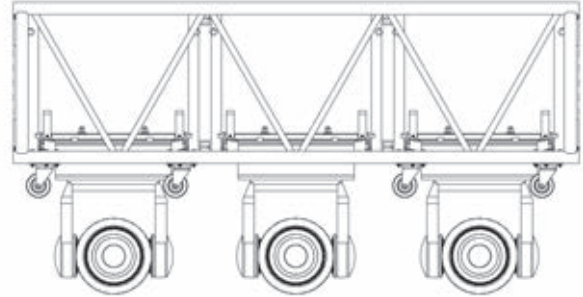

Front View with Lights in lowered position

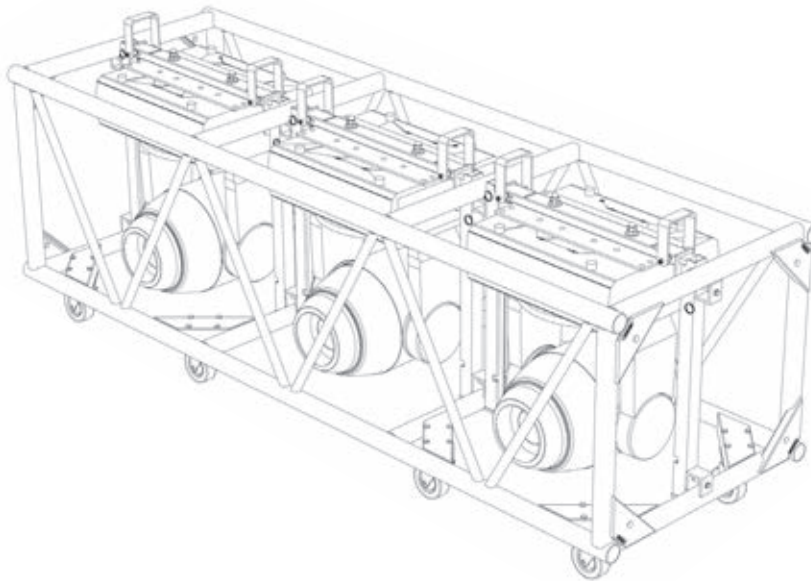

Loading chart

Allowable Load Data empty MLT	Maximum Allowable Uniform Loads		Maximum Allowable Center Point Loads	
	Span 7'-7" sections feet	Loads pounds	Maximum deflection inches	Loads pounds
2) 15.17	6926*	0.63	3463	0.945
3) 22.75	6084	1.26	3042	1.26
4) 30.33	4404	1.69	2202	1.69
5) 37.92	3341	2.09	1670	2.09
6) 45.5	2622	2.72	1311	2.72
7) 53.08	2080	3.66	1040	3.66
8) 60.67	1617	4.72	808	4.72

LOADING FIGURES show maximum loads between supports in addition to self weight of truss. Information extracted from structural report by The Broadhurst Partnership. * Denotes load limited to suit maximum shear capacity. All loads include a 20% overload factor for dynamic effects.

Ladders

James Thomas Engineering Ladder Truss is a great option for gigs where short spans and light loads are needed.

Also, custom ladders can be added to your current inventory of truss to create a custom roof system.



GENERAL PURPOSE 12" LADDER

12" General Purpose ladder truss is suitable for small loads and added lighting positions. Ladders are easily stacked and stored away when not in use.



MAIN CHORDS:

Chords are constructed of 2" outside diameter tubes with a wall thickness of 0.125" (1/8").

DIAGONALS:

Diagonals are made from 1 inch outside diameter tubes with a wall thickness of 0.125" (1/8").

CHANNEL:

End Bracing Channel:

End bracing is constructed of 2 inch x 2 inch channel with a wall thickness of 1/4". Bolt hole centers are 140mm (5.51").

FASTENERS:

Ladders are fastened together using (2) 5/8" UNC x 2" Bolt sets (grade 8).

WELDING:

Thomas truss is welded by certified welders in accordance with American National Standard ANSI/AWS D1.2-97.

DESIGN AND MANUFACTURING:

In accordance with the applicable sections of ANSI E1.2 -2000. "Design, Manufacture and Use of Aluminum Trusses and Towers"

Standard lengths and weights

PRODUCT CODE	DESCRIPTION	WT lbs
LD12GP120	10' Section	23.5
LD12GP096	8' Section	20.02
LD12GP084	7' Section	16.80
LD12GP072	6' Section	14.57
LD12GP060	5' Section	12.57
LD12GP048	4' Section	10.57
LD12GP024	2' Section	8.57

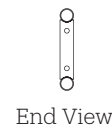
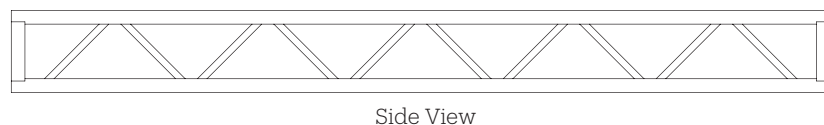

GENERAL PURPOSE 20.5" LADDER

20.5" General Purpose ladder truss is suitable for small loads and added lighting positions. Ladders are easily stacked and stored away when not in use.



Standard lengths and weights

PRODUCT CODE	DESCRIPTION	WT lbs
LD20GP120	10' Section	29
LD20GP096	8' Section	20.02
LD20GP084	7' Section	18.80
LD20GP072	6' Section	16.57
LD20GP060	5' Section	14.57
LD20GP048	4' Section	12.57
LD20GP024	2' Section	11.57



Plan View

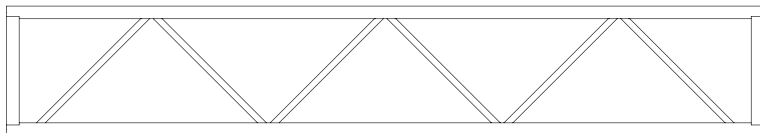

Side View



End View

SUPERTRUSS 12" LADDER

12" SuperTruss ladder is suitable for small loads and added lighting positions. With spigoted ends, loads are carried more efficiently along the truss. Spigots are turned so that runs of truss will not pivot at each connection location. Ladders are easily stacked and stored away when not in use.



Standard lengths and weights

PRODUCT CODE	DESCRIPTION	WT lbs
LD12ST120	10' Section	32.21
LD12ST096	8' Section	26.6
LD12ST084	7' Section	24.1
LD12ST072	6' Section	22.6
LD12ST060	5' Section	20.5
LD12ST048	4' Section	17.9
LD12ST024	2' Section	15.07



Plan View

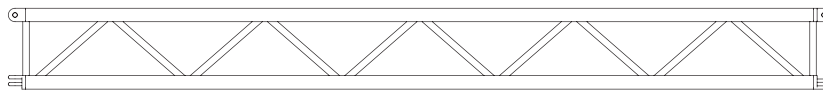

Side View



End View

SUPERTRUSS 20.5" LADDER

20.5" SuperTruss ladder is suitable for small loads and added lighting positions. With spigoted ends, loads are carried more efficiently along the truss. Spigots are turned so that runs of truss will not pivot at each connection location. Ladders are easily stacked and stored away when not in use.



Standard lengths and weights

PRODUCT CODE	DESCRIPTION	WT lbs
LD20ST120	10' Section	34.51
LD20ST096	8' Section	32.6
LD20ST084	7' Section	28.17
LD20ST072	6' Section	26.63
LD20ST060	5' Section	24.06
LD20ST048	4' Section	22.98
LD20ST024	2' Section	20.07



Plan View

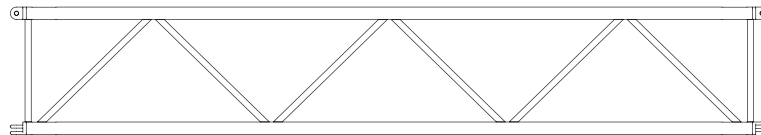

Side View



End View



SuperTruss

James Thomas SuperTruss utilizes a forked connection and heavier main chords resulting in higher load capacities and increased ease of assembly, while maintaining the light weight advantage of aluminum. As the weight and forces of modern productions increase, SuperTruss offers the staging, rigging, and lighting industry a variety of structural products capable of handling the job.

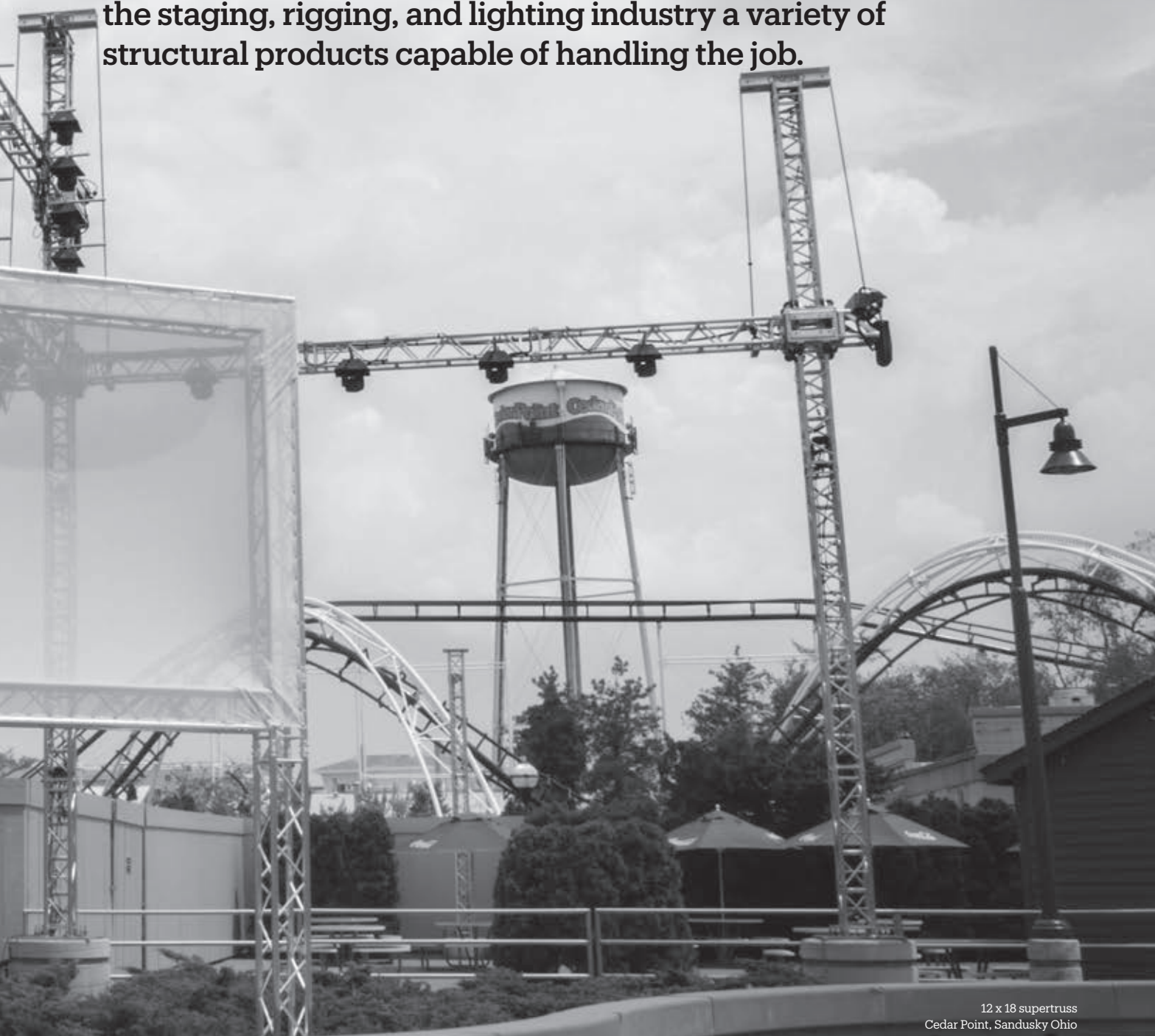

12 x 18 supertruss
Cedar Point, Sandusky Ohio

SUPERTRUSS 12 x 12

The revolutionary truss designed to offer all the advantages of the 20.5" SuperTruss in a 12" x 12" layout. The 12" x 12" SuperTruss provides a substantial increase in load bearing capacity over the existing GP 12" x 12" truss. The main chords of the truss are made from 2" x 0.157" 6061T6, and the diagonals are 1" x 0.125".



Standard lengths and weights

PRODUCT CODE	DESCRIPTION	WT lbs
B1260 R2	12' Section	87
B1261 R2	10' Section	70
B1262 R2	8' Section	67
B1263 R2	6' Section	51
B1264 R2	5' Section	40
B1265 R2	2' 6" Section	26

Truss Accessories

PRODUCT CODE	DESCRIPTION	WT lbs
B1204B	3 Way gate with lifting point load rating at 3,000lbs when loads are applied parallel to the slots in the 3/4" plate	8
B1208	Square support plate	4
B1211	12" SuperTruss to GP 12" x 12" adapter gate	7
G6671A	12" SuperTruss pin extraction tool	7

Corners

PRODUCT CODE	DESCRIPTION	WT lbs
B1200A	60° corner gate	14
B1201	90° corner gate	8
B1203	135° corner gate	5
B1204A	3 Way gate/ 120° gate	8



End View



Plan View



Front View



3 Way corner gate



90° corner gate



Corner plate

Loading chart

Allowable Load Data	Maximum Allowable Uniform Loads		Maximum Allowable Center Point Loads		
	Span feet	Loads pounds	Maximum deflection inches	Loads pounds	Maximum deflection inches
10		8496*	0.20	7348	0.20
20		7255	1.50	3628	1.50
30		3324	2.20	1662	2.20
40		1695	2.95	848	2.95
50		888	3.70	445	3.70

LOADING FIGURES show maximum loads between supports in addition to self weight of truss. Information extracted from structural report by Broadhurst, Goodwin & Dunn for SuperTruss manufactured after November 1993. * Denotes load limited to suit maximum shear capacity. All loads include 20% overload factor for dynamic effects.

SUPERTRUSS 15 × 15

Thomas has rethought truss design to encompass the changing demands of the touring industry. The supertruss design features new double end connectors, which are oriented so that the truss elements are unisex (they can be used either way). Made from 6061T6 or 6082T6 alloy, the truss has 2" x 0.157" main chord tubes and 1" x 0.125" diagonal tubes.

SuperTruss saves truck space because of its very high strength in relation to its size and also the space saving design of the corners. The corners are simplicity themselves. As for the 2 way corner, only a connecting gate is required to brace between the outer fork connectors. The 3 way corner only requires a connecting gate and 2 square connecting plates. The 4 way corner requires just 2 square connecting plates. In order to use the supertruss with towers, 2 sleeve connecting plates with roller wheels are required with 1 or 2 ladders depending on how many truss connections there are. 60° corners require 2 extended double fork connectors and a connecting gate. Other angles can be easily made to order. Variable and vertical connecting forks are available for 0 - 90° operation.



Standard lengths and weights

PRODUCT CODE	DESCRIPTION	WT lbs
B6512 R2	12' Section	96
B6510 R2	10' Section	80
B6508 R2	8' Section	64
B6505 R2	5' Section	40
B6503 R2	2' 6" Section	23

Corners

PRODUCT CODE	DESCRIPTION	WT lbs
B6500	60° corner gate	33
B6501	90° corner gate	11
B6502	3 Way / 120° corner gate	10
B6503	135° corner gate	8.5

Truss Accessories

PRODUCT CODE	DESCRIPTION	WT lbs
B6505	3 Way gate with lifting point	9
B6507	Square support plate	11
B6514	Lifting point for 15" super-truss	-

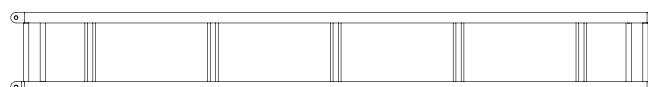

Plan View

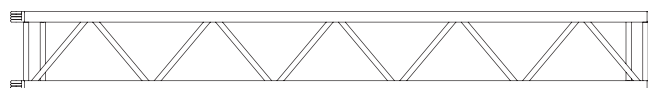

Front View



End View

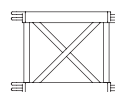

90° GATE



3-WAY/120° GATE

Loading chart

Allowable Load Data	Maximum Allowable Uniform Loads		Maximum Allowable Center Point Loads		
	Span feet	Loads pounds	Maximum deflection inches	Loads pounds	Maximum deflection inches
10		10,097	0.22	9,372	0.22
20		9,252	1.09	4,626	1.09
30		5,539	2.25	2,770	2.25
40		2,931	3.0	1,466	3.0
50		1,478	3.75	739	3.75
60		607	4.5	304	4.5

LOADING FIGURES show maximum loads between supports in addition to self weight of truss. * Denotes load limited to suit maximum shear capacity. All loads include a 20% overload factor for dynamic effects.

SUPERTRUSS 18 x 12

A revolutionary truss designed to offer all the advantages of the Thomas SuperTruss design in a 12 x 18 layout. This truss has the advantage of being able to accommodate 2 lighting bars back to back. 12 x 18 SuperTruss provides a substantial increase in loadbearing capacity over the GP 18 x 12 truss. It is made from 6061T6 alloy 2" x 0.157" tubes in the main chords and 1" x 0.125" tubes in the diagonals.



Standard lengths and weights

PRODUCT CODE	DESCRIPTION	WT lbs
B2360 R2	12' Section	93
B2361 R2	10' Section	76
B2362 R2	8' Section	64
B2363 R2	6' Section	48
B2364 R2	5' Section	45
B2365 R2	2' 6" Section	20

Truss Accessories

PRODUCT CODE	DESCRIPTION	WT lbs
B2304B	3 Way gate with lifting point	12
B2308	Square support plate	10
B2311	18" x 12" SuperTruss to GP 18" x 12" adapter gate	9
G6671A	12" SuperTruss pin extraction tool	7

Corners

PRODUCT CODE	DESCRIPTION	WT lbs
B2300A	60° corner gate	22
B2301 R2	90° corner gate	9
B1203	135° corner gate	8
B2304A R2	3 Way gate/ 120° gate	9



End View



Side View

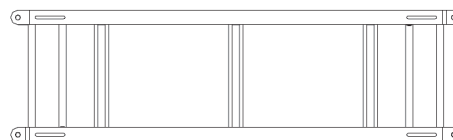

Plan View

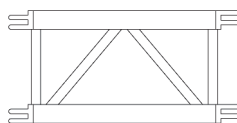

90 Degree corner gate

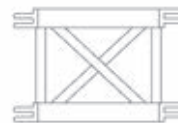

3 Way corner gate

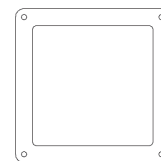

Square support plate

Loading chart

Allowable Load Data Span feet	Maximum Allowable Uniform Loads		Maximum Allowable Center Point Loads	
	Loads pounds	Maximum deflection inches	Loads pounds	Maximum deflection inches
10	8496*	0.20	7348	0.20
20	7255	1.50	3628	1.50
30	3324	2.20	1662	2.20
40	1695	2.95	848	2.95
50	888	3.70	445	3.70

LOADING FIGURES show maximum loads between supports in addition to self weight of truss. Information extracted from structural report by Broadhurst, Goodwin & Dunn for SuperTruss manufactured after November 1993. * Denotes load limited to suit maximum shear capacity. All loads include 20% overload factor for dynamic effects.

SUPERTRUSS 20.5 × 20.5

Thomas has rethought truss design to encompass the changing demands of the touring industry. The SuperTruss design features new double end connectors, which are orientated so that the truss elements are unisex (they can be used either way). Made from 6061T6 or 6082T6 alloy, the truss has 2" x 0.157" main chord tubes and 1" x 0.125" diagonal tubes. SuperTruss saves truck space because of its very high strength in relation to its size and also the space saving design of the corners.

The corners are simplicity themselves. As for the 2 way corner, only a connecting gate is required to brace between the outer fork connectors. The 3 way corner only requires a connecting gate and 2 square connecting plates. The 4 way corner requires just 2 square connecting plates. In order to use the supertruss with towers, 2 sleeve connecting plates with roller wheels are required with 1 or 2 ladders depending on how many truss connections there are. 60° corners require 2 extended double fork connectors and a connecting gate. Other angles can be easily made to order. Variable and vertical connecting forks are available for 0 - 90° operation.



Standard lengths and weights

PRODUCT CODE	DESCRIPTION	WT lbs
B20144	12' Section	90.5
B20120	10' Section	86
B20096	8' Section	70.5
B20072	6' Section	58.5
B20060	5' Section	49.5
B20030	2' 6" Section	38.5

Corners

PRODUCT CODE	DESCRIPTION	WT lbs
B20-060G	60° corner gate	33
B20-090G	90° corner gate	11
B20-120G	3 Way gate	10
B20-135G	135° corner gate	8.5

Truss Accessories

PRODUCT CODE	DESCRIPTION	WT lbs
B20-120LG	3 Way gate/ 120° Lifting gate	20
B20-120TLG	Tower Lifting Gate	30
B1306	Vertical connecting fork	1.3
B1307	Horizontal connecting fork	2.2
B20-SSP	Square support plate	11
B20-12SP	12" Tower sleeve plate	26.5
B20-15SP	15" Tower sleeve plate	26.5
B1311	SuperTruss to GP20.5x20.5 adapter gate	14
B1312	Lifting point for SuperTruss	12

Loading chart

Allowable Load Data Span feet	Maximum Allowable Uniform Loads		Maximum Allowable Center Point Loads	
	Loads pounds	Maximum deflection inches	Loads pounds	Maximum deflection inches
10	7405*	0.433	7405	0.670
20	7405*	0.433	7405	0.670
30	7326*	1.77	5870	1.77
40	6435	3.0	3219	3.0
50	3918	3.7	1960	3.7
60	2476	4.4	1239	4.4
70	1611	5.2	807	5.2
80	996	5.9	498	5.9

LOADING FIGURES show maximum loads between supports in addition to self weight of truss. Information extracted from structural report by The Broadhurst Partnership. * Denotes load limited to suit maximum shear capacity. All loads include a 20% overload factor for dynamic effects.

SINGLE BAR PRE-RIG SUPERTRUSS

A revolutionary truss designed to offer all the advantages of the Thomas SuperTruss but in Single bar Pre-Rig layout. The size is 15" x 26" deep. (38cm x 66cm).

The truss features a hinging guide rod support gate for ease of allowing the lighting bar to be rigged and derigged through the top of the truss. This truss allows the use of standard lighting bar or pre-rig lighting bar. Ideal for users where a small truck pack is required.



Standard lengths and weights

PRODUCT CODE	DESCRIPTION	WT lbs
B2732	10' 6" section	50.5
B2724	8' section	40
B2717	5' 6" section	36
B2712	4' section	17.9

Corners

PRODUCT CODE	DESCRIPTION	WT lbs
B2700	60° corner gate	9
B2701	90° corner gate	6
B2702	120° corner gate	5
B2704	135° corner gate	4
B2703	3 Way gate	5.5

Truss Accessories

PRODUCT CODE	DESCRIPTION	WT lbs
B2703A	3 Way gate with lifting point	10.5
B2708	Square support plate	5
B2709A	12" Tower sleeve plate	9
B2709B	15" Tower sleeve plate	8.5
B1307	Horizontal connecting forks 2/unit	1
B2709	Double add on caster bars	5

Loading chart

Allowable Load Data empty Pre-rigged SuperTruss Span 8' sections feet	Maximum Allowable Uniform Loads		Maximum Allowable Center Point Loads	
	Loads pounds	Maximum deflection inches	Loads pounds	Maximum deflection inches
2) 16	7355*	0.12	7355*	0.
4) 32	7209*	0.98	4215	0.98
5) 40	5683	1.6	2842	1.6
6) 48	4303	2.2	2152	2.2
8) 64	2568	3.5	1285	3.5
10) 80	1534	5.0	767	5.0
11) 88	1142	5.79	571	5.79

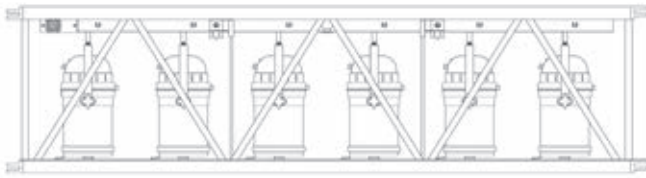

Par 64 lanterns in storage position

To lower lanterns from storage to operating position, simply pull tab on shank hook with one hand while holding the lighting bar with the other hand. Then lower the lanterns into operating position.

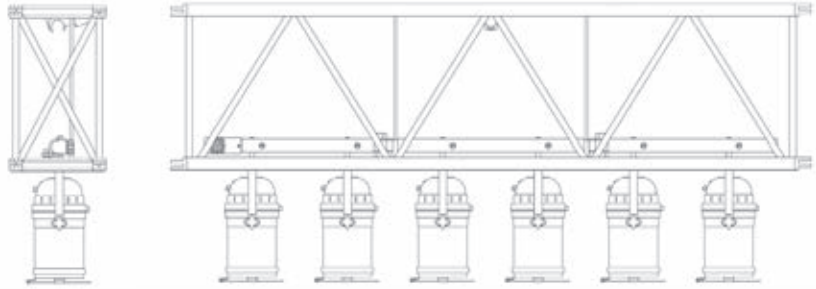

Par 64 lanterns lowered to operating position

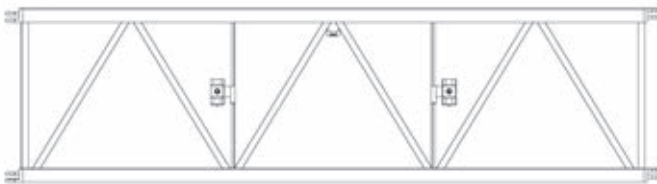

8' section



End View

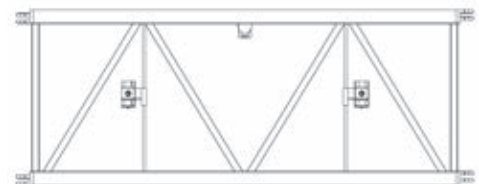

5' 6" section

(Connecting forks are shown larger for clarity)

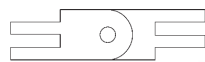

Horizontal connecting fork 2 per unit



Plan View

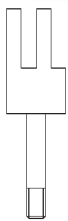

Vertical connecting fork



60° corner gate



90° corner gate



3 Way gate



Square support plate

SUPERTRUSS 20.5 × 30

A revolutionary truss designed to offer all the advantages of the Thomas SuperTruss design in a 20.5" x 30" layout. This truss is designed for the very long spans and heavy loading requirements for the entertainment industry. This truss is made using 6061T6 alloy 1.5" Schedule 80 for the main chords and 1.25" Schedule 80 for the diagonals. The 20.5" x 30" SuperTruss provides a substantial increase in load bearing capacity over GP Heavy Duty Truss.



Standard lengths and weights

PRODUCT CODE	DESCRIPTION	WT lbs
E2960	12' Section	143
E2961	10' Section	114
E2962	8' Section	95
E2966	6' Section	78
E2965	4' Section	71
E2964	5' Section	71
E2963	2' 6" Section	71

Truss Accessories

PRODUCT CODE	DESCRIPTION	WT lbs
B2905	3 Way gate with lifting point	18
B20-SSP	Horizontal connecting fork	29
B1308	Square support plate	11
B20-12SP	12" Tower sleeve plate	26.5
B20-15SP	15" Tower sleeve plate	26.5
B2911	SuperTruss to GP20.5x20.5 adapter gate	18

Corners

PRODUCT CODE	DESCRIPTION	WT lbs
E2900A	60° corner gate	40
E2901A	90° corner gate	18
E2902	120° corner gate	17
E2903	135° corner gate	17
E2904	3 Way gate	17

Loading chart

Allowable Load Data Span feet	Maximum Allowable Uniform Loads		Maximum Allowable Center Point Loads	
	Loads pounds	Maximum deflection inches	Loads pounds	Maximum deflection inches
10	14110*	0.042	14114*	0.067
20	14020*	0.335	9385*	0.361
30	12360*	1.005	6182	0.814
40	9120	1.786	4557	1.453
50	7150	2.79	3565	2.282
60	5760	4.006	2888	3.307

LOADING FIGURES show maximum loads between supports in addition to self-weight of truss. Information extracted from structural report by Clark-Reder Engineering, Inc.
* Denotes load limited to suit maximum shear capacity. All loads include a 20% overload factor for dynamic effects. For loads based on repetitive use, please reduce by 0.85.

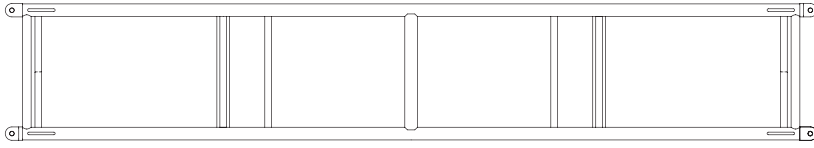

Plan View

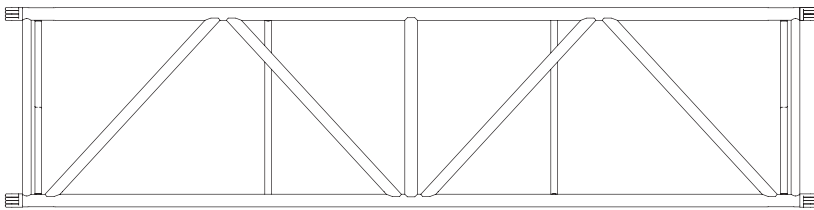

Front View

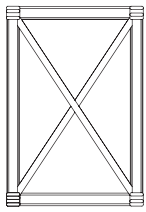

End View

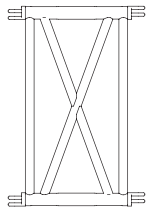

B2904

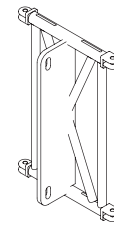
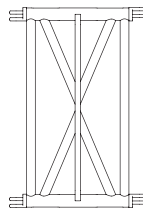

B2905



PRE-RIG SUPERTRUSS

This revolutionary truss is designed to offer all the advantages of SuperTruss in a 26" x 30" Pre-rigged layout. The design features casters for mobility, removable guide rod support gates for ease of installing and removing pre-rigged or standard lighting bars. Pre-rigged supertruss provides a substantial increase in load bearing capacity over the flat plate pre-rigged truss. It is made from either a 6061T6 or a 6082T6 aluminum alloy. The main chords are 2" x 0.157" and the diagonals are 1" x 0.125" tube.



Standard lengths and weights

PRODUCT CODE	DESCRIPTION	WT lbs
B1430	10' 6" section	118
B1424	8' section	97
B1416	5'6" section	86
B1412	4' section	46

Corners

PRODUCT CODE	DESCRIPTION	WT lbs
B1400	60° corner gate	36
B1401	90° corner gate	16
B1402	120° corner gate	12.1
B1403	135° corner gate	11
B1404	3 Way gate	14

Truss Accessories

PRODUCT CODE	DESCRIPTION	WT lbs
B1306	Vertical connecting fork	1.3
B1307	Horizontal connecting forks 2/unit	2.2
B1405	3 Way gate with lifting point	-
B1408	Square support plate	16
B1409A	12" Tower sleeve plate	51
B1409B	15" Tower sleeve plate	49
B1411	SuperTruss to P.R.T. adapter plate	-
B1413	Lifting point for P.R. SuperTruss	-

Loading chart

Allowable Load Data empty Pre-rigged SuperTruss	Maximum Allowable Uniform Loads		Maximum Allowable Center Point Loads	
	Span 8' sections	Loads pounds	Maximum deflection inches	Loads pounds
2) 16	7339*	0.12	7339*	0.945
3) 24	7251*	0.43	7251*	1.26
4) 32	7162*	1.0	7162*	1.69
5) 40	7074*	1.9	5454	1.9
6) 48	6556	3.55	3428	3.55
7) 56	5112	4.14	2557	4.14
8) 64	3668	4.72	1834	4.72
9) 72	2668	5.32	1334	5.32
10) 80	1884	5.9	941	5.9
11) 88	1314	6.5	657	6.5

LOADING FIGURES show maximum loads between supports in addition to self weight of truss. Information extracted from structural report by The Broadhurst Partnership. * Denotes load limited to suit maximum shear capacity. All loads include a 20% overload factor for dynamic effects.

To lower lanterns from storage to operating position, simply pull tab on shank hook with one hand while holding the lighting bar with the other hand. Then lower the lanterns into operating position.

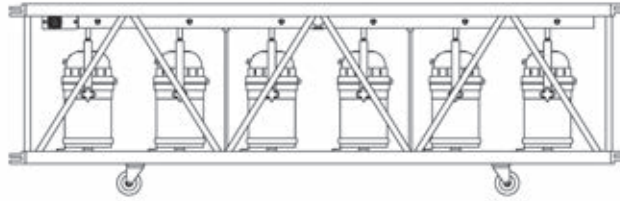

Par 64 lanterns in storage position

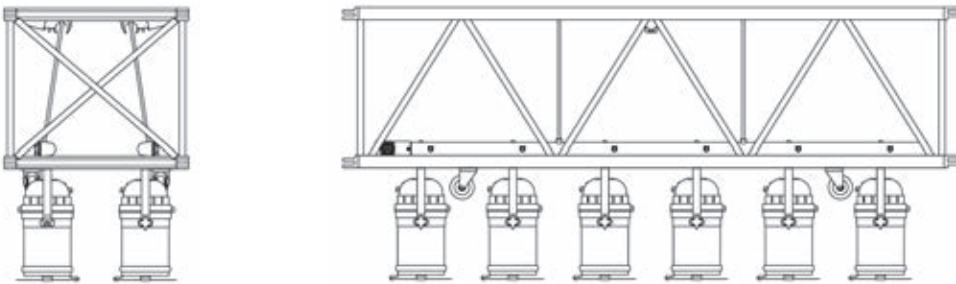

Par 64 lanterns lowered to operating position

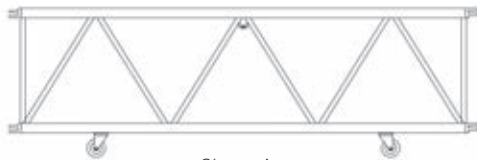

8' section

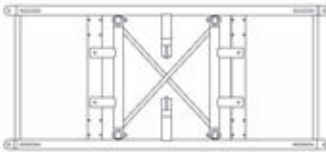

5' 6" section



End View

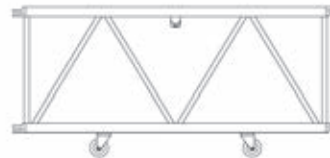

Side View

(Connecting forks are shown larger for clarity)

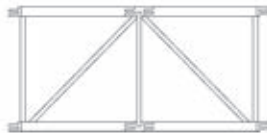

60° corner gate



90° corner gate

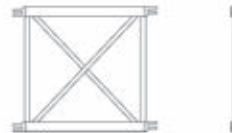

3 Way gate



Vertical connecting fork



Horizontal connecting fork
2 per unit



Square support plate

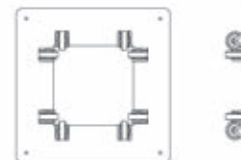

15" Tower sleeve plate

MOVING LIGHT SUPERTRUSS

Moving Light supertruss has been designed around the Pre-rigged SuperTruss size. 96" x 30" x 26" in size (other sizes are available). Moving light SuperTruss provides a substantial increase in load bearing capacity over the flat plate pre-rigged truss. It is manufactured from aluminum tube 6061T6 or 6082-T6 with 2" x .157" wall thickness for main tubes and 1" x .125" wall tube for the diagonals. Each truss piece has 8 caster wheels for easy maneuverability and pins and R-clips for the connection of truss pieces.

Each 96" truss is designed to carry 3 moving light fixtures. The moving lights are stored internally in the truss and can be lowered to the working position when in use. This design reduces the amount of space required for lighting and rigging in the truck.

Two handles allow the lowering of each moving light.

The whole system can be used with our Ground Support System by using suitable sleeve blocks and towers.

Please note: no fixtures are included with truss.



Standard lengths and weights

PRODUCT CODE	DESCRIPTION	WT lbs
MLT-ST-96-R1	8' section (empty)	145**

Corners

PRODUCT CODE	DESCRIPTION	WT lbs
B1400	60° corner gate	36
B1401	90° corner gate	16
B1402	120° corner gate	12.1
B1403	135° corner gate	11
B1404	3 Way gate	14

Truss Accessories

PRODUCT CODE	DESCRIPTION	WT lbs
B1306	Vertical connecting fork	1.3
B1307	Horizontal connecting forks 2/unit	2.2
B1405	3 Way gate with lifting point	-
B1408	Square support plate	16
B1409A	12" Tower sleeve plate	51
B1409B	15" Tower sleeve plate	49
B1411	SuperTruss to PRT adapter plate	-
B1413	Lifting point for PRT SuperTruss	-
	** weights subject to change	

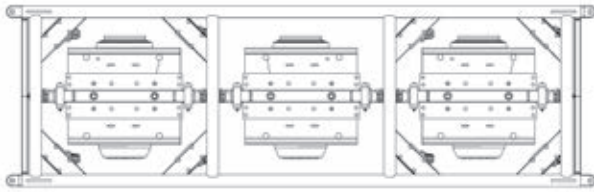

Plan View

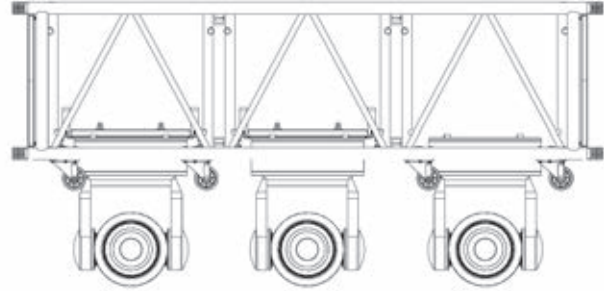

Front View with Lights in lowered position

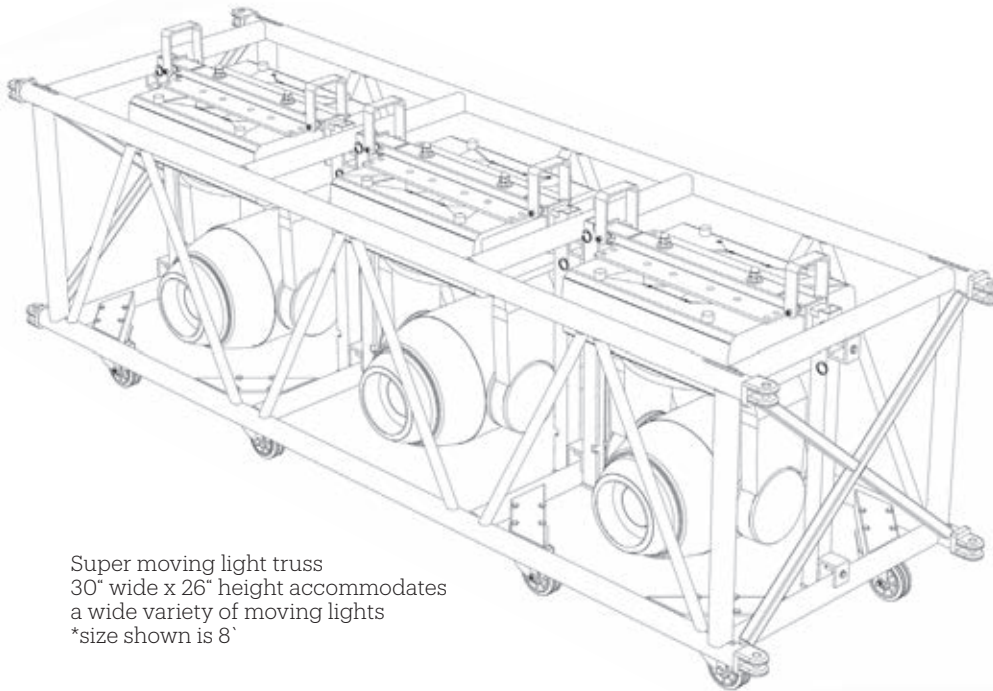

Super moving light truss
 30" wide x 26" height accommodates
 a wide variety of moving lights
 *size shown is 8'

Loading chart

Span (ft)	Swt (lb)	Swt-MT (ft-lb)	Uniform Dist. Loads		Center Point Loads	
			(lb)	Max. Deflection (in)	(lb)	Max. Deflection (in)
16	240	480	13580*	0.18	12550	0.18
24	360	1080	13460*	0.60	8387	0.60
32	480	1920	12550	1.34	6275	1.34
40	600	3000	10016	2.13	5008	2.13
48	720	4820	8327	3.14	4163	3.14
56	840	5880	6400	3.99	3200	3.99
64	960	7680	5375	5.21	2688	5.21
72	1080	9720	3290	5.12	1645	5.12
80	1200	12000	2003	5.15	1002	5.15

*Denotes load limited to suit maximum shear capacity.

20.5" FOLDING SUPERTRUSS

This SuperTruss has been developed for those applications that require good loadbearing capacity and a compact truck pack . The truss ladders are separated at the bottom by folding locking elbows and are hinged at the top with our custom made extrusion. All sections fold flat to a width of 5.25" to take up the smallest amount of space possible. Forty feet of folding truss requires about the same space as a 1 - 10 foot section of 20.5 inch SuperTruss.



Standard lengths and weights

PRODUCT CODE	DESCRIPTION	WT lbs
B3660A	12' of 20.5" Folding SuperTruss	99
B3661	10' of 20.5" Folding SuperTruss	88
B3662	8' of 20.5" Folding SuperTruss	74
B3663	6' of 20.5" Folding SuperTruss	59
B3664	5' of 20.5" Folding SuperTruss	54
B3666	4' of 20.5" Folding SuperTruss	52

Truss Accessories

PRODUCT CODE	DESCRIPTION	WT lbs
B3605	2 Way Folding SuperTruss square support plate	-
B3603	3 Way Folding SuperTruss joint c/w square support plate	-
B3604	4 Way Folding SuperTruss joint c/w square support plate	-
B3607	Add on caster bars	-
B2609	Folding SuperTruss lifting point	-
B3611	0 - 180° Pivot section	-

Loading chart

Allowable Load Data Span feet	Maximum Allowable Uniform Loads		Maximum Allowable Center Point Loads	
	Loads pounds	Maximum deflection inches	Loads pounds	Maximum deflection inches
10	6680	0.44	5732	0.59
20	6680	0.44	5732	0.59
30	6609	1.50	3783	1.50
40	4616	2.56	2308	2.56
50	3256	3.70	1629	3.70
60	2050	4.41	1025	4.41
70	1300	5.15	650	5.15
80	798	5.90	399	5.90

LOADING FIGURES show maximum loads between supports in addition to self weight of truss. Information extracted from structural report by The Broadhurst Partnership. * Denotes load limited to suit maximum shear capacity. All loads include 20% overload factor for dynamic effects.

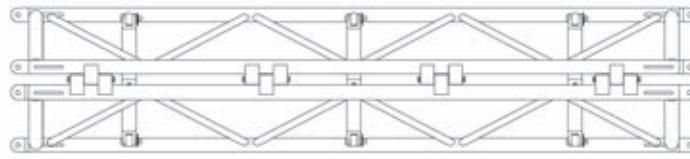

Plan View



Front View



Isometric drawing showing the 2 Way corner assembly.

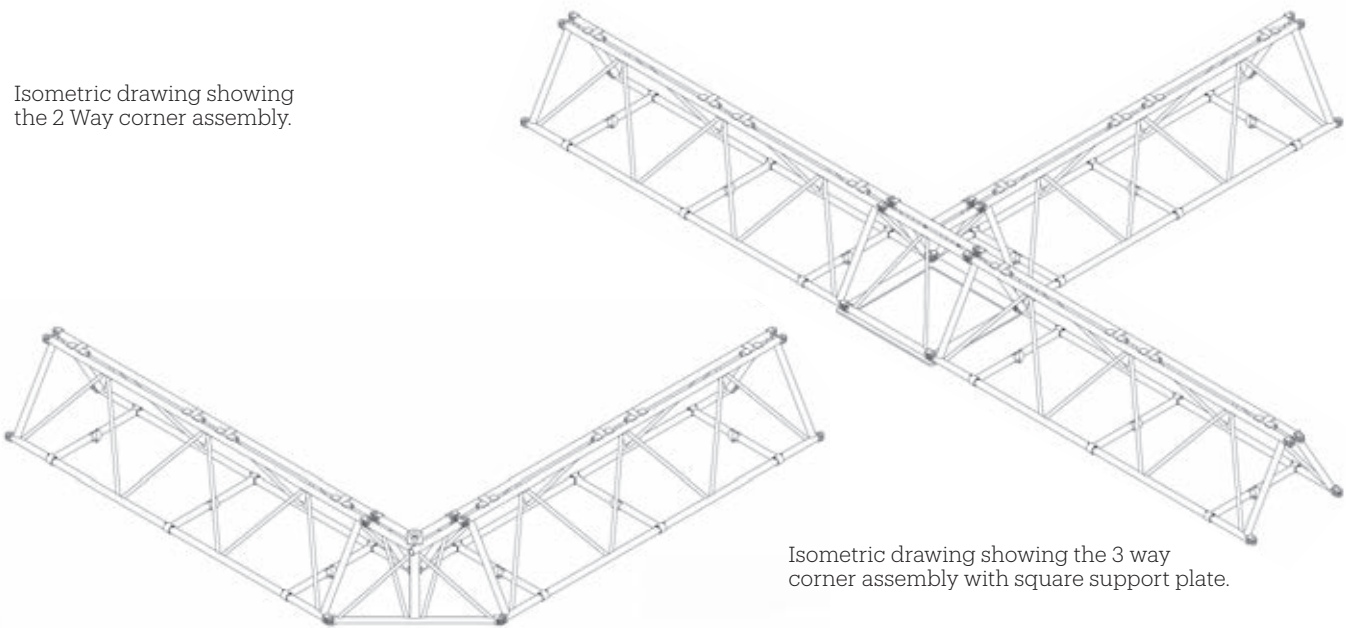

Isometric drawing showing the 3 way corner assembly with square support plate.

GALAXY 240



Truss (Standard Lengths)

PRODUCT CODE	DESCRIPTION	WT lbs
G240T120	10' section - truss	134
G240D120	10' section - dolly	162
G240T096	8' section - truss	116
G240D096	8' section - dolly	157

Loading chart

Span (ft)	Swt (lb)	Uniform Dist. Loads		Center Point Loads	
		(lb)	Max. Deflection (in)	(lb)	Max. Deflection (in)
10	134	7050*	0.10	7050*	0.15
20	268	7460**	0.75	3730	0.61
30	402	4750	1.69	2375	1.38
40	536	3314+	3.00	1657	2.48
50	670	1794+	3.75	897	3.21
60	804	906+	4.50	453	4.02

ATTENTION! Loading figures show MAXIMUM LOADS between supports in addition to SELF WEIGHT of truss.

* Denotes load limited by maximum unistrut capacity

** Denotes load limited by maximum shear capacity

+ Denotes load limited by maximum deflection of span/160

General Information:

TRUSS:

- Material: aluminum 6061T6 & stainless steel
- Your choice of Thomas SuperTruss fork or TOMCAT Edge connections
- Adjustable mounting bars for conventional or moving lights
- Removable stacking cup
- Available gates allow flexible designs
- Space saving 15" design allows for easy fixture pack
- High load capacity
- Ideal for touring or any venue

DOLLY:

- Material: aluminum 6061T6
- Allows ample working area for fixtures
- Available spring dampening unit
- Dolly folds away & stacks
- 24" model makes for tighter truck pack
- Outside wheels for stability



Plan View

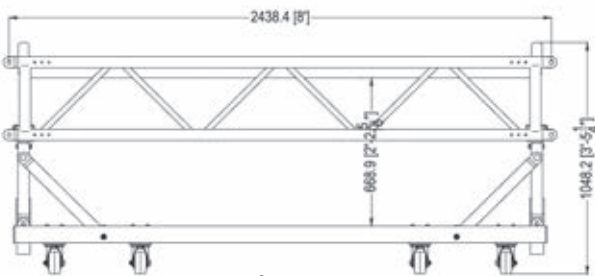

Side View
Shortest Position

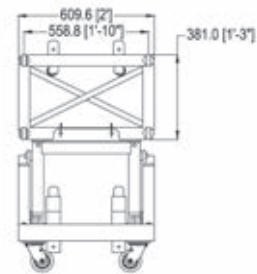

End View

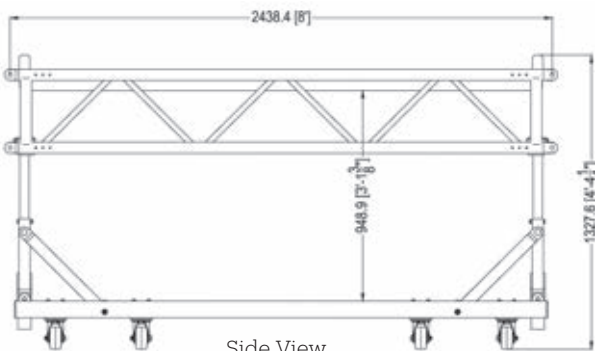

Side View
Tallest Position

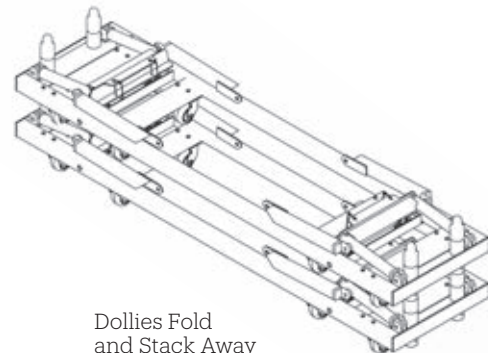

Dollies Fold
and Stack Away

GALAXY 300



Truss (Standard Lengths)

PRODUCT CODE	DESCRIPTION	WT lbs
G300T120	10' section - truss	144
G300D120	10' section - dolly	170
G300T096	8' section - truss	122
G300D096	8' section - dolly	169

Loading chart

Span (ft)	Swt (lb)	Uniform Dist. Loads		Center Point Loads	
		(lb)	Max. Deflection (in)	(lb)	Max. Deflection (in)
10	144	7050*	0.09	7050*	0.14
20	288	7450**	0.80	3730	0.59
30	432	4760	1.73	2380	1.41
40	576	3320	3.07	1660	2.55
50	720	1720+	3.75	860	3.22
60	864	820+	4.50	410	4.06

ATTENTION! Loading figures show MAXIMUM LOADS between supports in addition to SELF WEIGHT of truss.

* Denotes load limited by maximum unistrut capacity

** Denotes load limited by maximum shear capacity

+ Denotes load limited by maximum deflection of span/160

General Information:

TRUSS:

- Material: aluminum 6061T6 & stainless steel
- Your choice of Thomas SuperTruss fork or TOMCAT Edge connections
- Adjustable mounting bars for conventional or moving lights
- Removable stacking cup
- Available gates allow flexible designs
- Space saving 15" design allows for easy fixture pack
- High load capacity
- Ideal for touring or any venue

DOLLY:

- Material: aluminum 6061T6
- Allows ample working area for fixtures
- Available spring dampening unit
- Dolly folds away & stacks

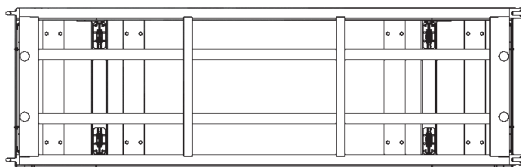

Plan View

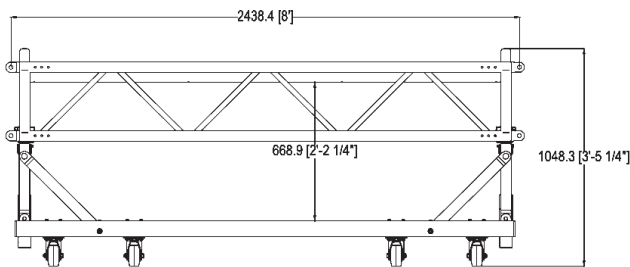

Side View
Shortest Position

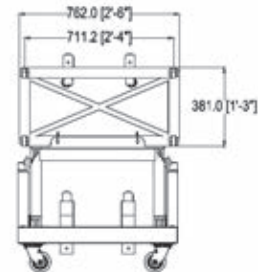

End View

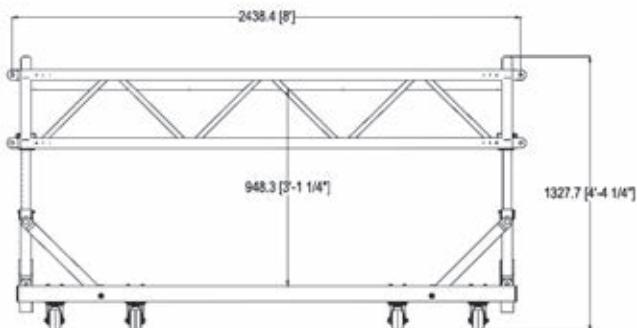

Side View
Tallest Position

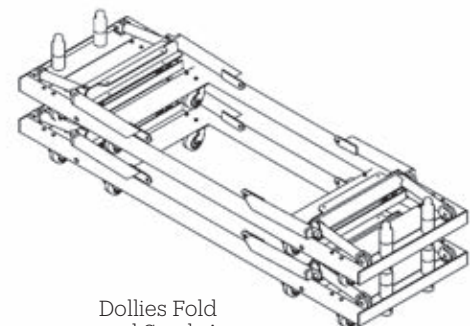

Dollies Fold
and Stack Away

SuperMega Truss

SuperMega Truss has been developed for applications that require monumental load bearing capabilities with minimal deflection. James Thomas SuperMega Truss is an excellent basis for large roof systems and “Mothergrids” that support today’s bigger and better performances.



SUPERMEGA TRUSS 500 × 1000

SuperMega Truss has been developed for those applications that require monumental loadbearing capacity. The truss is manufactured from 6082T6 or 6061T6 tube using 3" diameter main tubes, 1.96" cross boom tubes and 1.5" diagonals. The end connection is a scaled up version of the SuperTruss fork ensuring the required easy and strong connection qualities. Manoeuvrability is ensured by the standard fitting of casters. This truss has a maximum clear span capability of 127' without lateral restraint. If there is lateral restraint available mid span, then the maximum span can be up to 157'. This truss is an excellent basis for a "Mothergrid" or a large Roof System.



Standard lengths and weights

PRODUCT CODE	DESCRIPTION	WT lbs
B28020	20' SuperMega Truss	
B28015	15' SuperMega Truss	
B28012	12' SuperMega Truss	
B28010	10' SuperMega Truss	
B28008	8' SuperMega Truss	
B28005	5' SuperMega Truss	

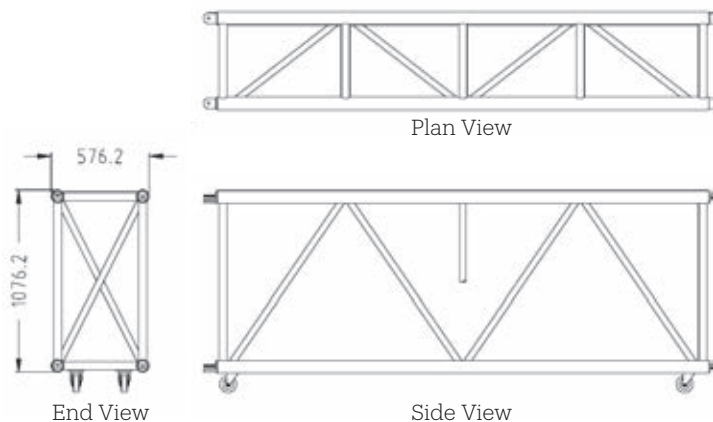

Truss Accessories

PRODUCT CODE	DESCRIPTION	WT lbs
B2802	2 Way Gate	34
B2803	3 Way Gate	29
B2803A	3 Way Gate with lifting point	44
B2808	Square support plate	10
B2809	15" Tower Sleeve Plate	50
BB2812	Lifting point for SuperMegatruss	20

Loading chart

Span feet	Maximum Allowable Load Data		
	Self Weight pounds	Uniformly Distributed Load pounds	Center Point Load pounds
20	326	10,670*	10,670*
40	711	10,670*	10,670
60	1,066	10,317*	7,460
80	1,422	9,442	4,722
100	1,777	3,913	1,957
120	2,133	1,084	542
128	2,310	240	121

LOADING FIGURES show maximum loads between supports in addition to self weight of truss. Information extracted from structural report by The Broadhurst Partnership. * Denotes load limited to suit maximum shear capacity.



36 x 36 SuperMgea Roof system with 30 x 30 Supermega towers, Downtown Las Vegas Event Center

SUPERMEGA TRUSS & TOWER 30 x 30

In line with our other SuperMega products, James Thomas Engineering has produced a 30" x 30" tower. This diverse product can be used either as a tower or as truss. It is built for applications requiring heavy loading and/or height capabilities. Made from 6061T6 alloy, the truss has 3" OD x 1/4" main chords and 2" x 0.157" diagonal tubes. Tower: When the desired working load is 13,000 pounds, this tower when standing alone can be a maximum of 56' with the appropriate anchorage base plate. As a goal post, the maximum height will be 73' and 110' when used as a corner in a 4 post grid (both with the appropriate anchorage base plate). When the desired working load is 26,000 pounds, this tower when standing alone can be a maximum of 40' with the appropriate anchorage base plate. As a goal post, 54' will be the maximum height and 81' when used as a corner in a 4 post grid (both with the appropriate anchorage base plate).

Truss loading figures are indicated in the chart overleaf:



Standard lengths and weights

PRODUCT CODE	DESCRIPTION	WT lbs
B31240	20' SuperMega Truss	378
B31144	12' SuperMega Truss	227
B31120	10' SuperMega Truss	189
B31096	8' SuperMega Truss	162
B31060	5' SuperMega Truss	126

Truss Accessories

PRODUCT CODE	DESCRIPTION	WT lbs
B3105	3 way gate with lifting point	-
B3106	Sleeve Block (30" tower)	341

Corners

PRODUCT CODE	DESCRIPTION	WT lbs
B3100	60° corner gate	-
B3101	90° corner gate	-
B3102	120° corner gate	-
B3103	135° corner gate	-
B3104	3 way gate	31

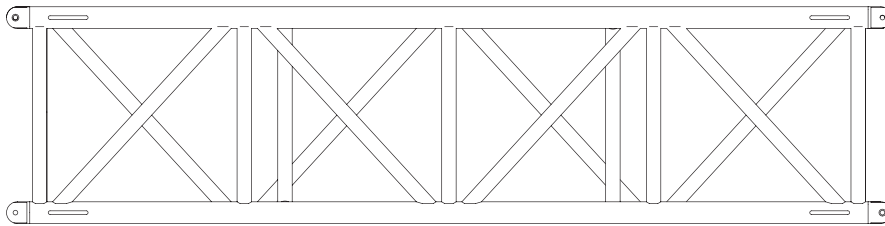

PLAN VIEW

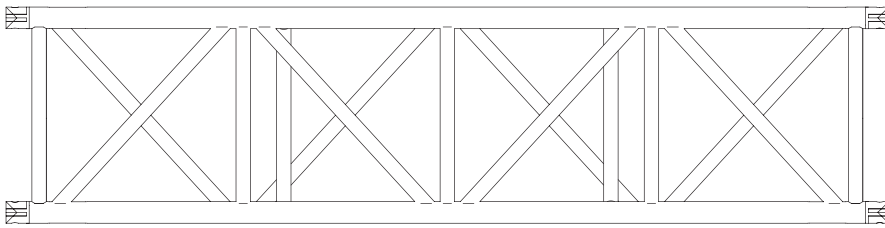

FRONT VIEW

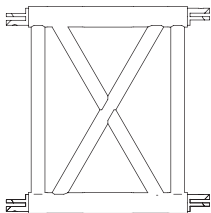

B3105

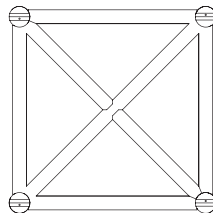

END VIEW

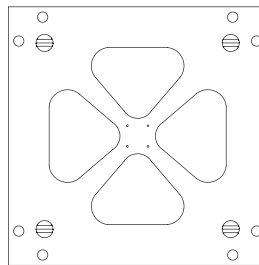

TOWER BASE PLATE

Loading chart

Allowable Load Data	Maximum Allowable Uniform Loads		Maximum Allowable Center Point Loads	
	Span feet	Loads pounds	Maximum deflection inches	Loads pounds
10	10,670*	0.433*	10,670*	0.670*
20	10,670*	0.433*	10,670*	0.670*
30	10,670*	1.77*	10,670*	1.77*
40	10,670*	3.0*	10,670*	3.0*
50	10,317*	3.7*	7,460*	3.7*
60	10,317*	4.4*	7,460*	4.4*
70	9,442*	5.2*	4,712*	5.2*
80	9,442*	5.9*	4,712*	5.9*

LOADING FIGURES show maximum loads between supports in addition to self weight of truss. * Denotes load limited to suit maximum shear capacity. All loads include 20% overload factor for dynamic effects.

SUPERMEGA TRUSS 36 × 36

In line with our other SuperMega products, James Thomas Engineering has produced a 36" x 36" truss. This diverse product can be used either as a tower or as truss. It is built for applications requiring heavy loading and/or height capabilities. Made from 6061T6 alloy, the truss has 3" OD x 1/4" main chords and 2" x 0.157" diagonal tubes.

Truss loading figures are indicated in the chart overleaf:



Standard lengths and weights

PRODUCT CODE	DESCRIPTION	WT lbs
B17240	20' SuperMega Truss	378
B17144	12' SuperMega Truss	227
B17120	10' SuperMega Truss	189
B17096	8' SuperMega Truss	162
B17060	5' SuperMega Truss	126

Truss Accessories

PRODUCT CODE	DESCRIPTION	WT lbs
B1704	3 way gate	-
B1705	3 way gate with lifting point	-
B3112	Lifting point for SuperMega Truss	26

Corners

PRODUCT CODE	DESCRIPTION	WT lbs
B1700	60° corner gate	-
B1701	90° corner gate	-
B1702	120° corner gate	-
B1703	135° corner gate	-

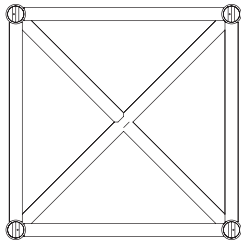

END VIEW

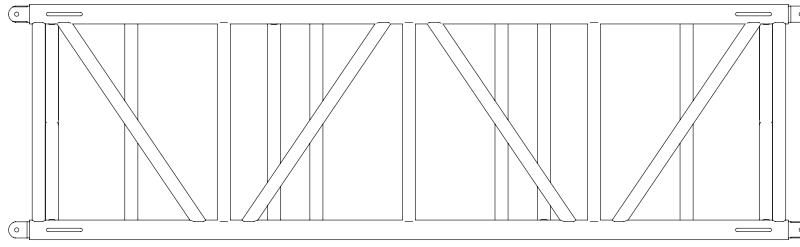

PLAN VIEW

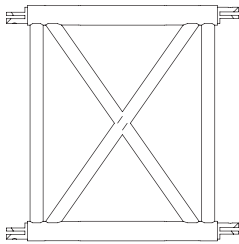
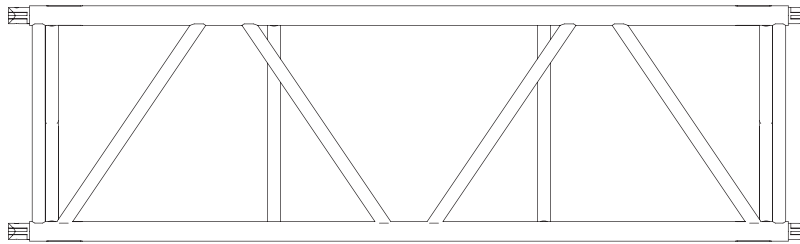
 B3104
3-WAY GATE

FRONT VIEW

Loading chart

Allowable Load Data Span feet	Maximum Allowable Uniform Loads		Maximum Allowable Center Point Loads	
	Loads pounds	Maximum deflection inches	Loads pounds	Maximum deflection inches
10	10,670*	0.433*	10,670*	0.670*
20	10,670*	0.433*	10,670*	0.670*
30	10,670*	1.77*	10,670*	1.77*
40	10,670*	3.0*	10,670*	3.0*
50	10,317*	3.7*	7,460*	3.7*
60	10,317*	4.4*	7,460*	4.4*
70	9,442*	5.2*	4,712*	5.2*
80	9,442*	5.9*	4,712*	5.9*

LOADING FIGURES show maximum loads between supports in addition to self weight of truss. * Denotes load limited to suit maximum shear capacity. All loads include 20% overload factor for dynamic effects.

CIRCLES AND CUSTOM SHAPES



CIRCLES AND CUSTOM SHAPES CAN BE FORMED IN ANY TRUSS SIZE BASED ON CLIENT NEEDS



IF CIRCLES ARE HUNG IN A VERTICAL POSITION, DIAGONALS MUST BE IN ALL FACES

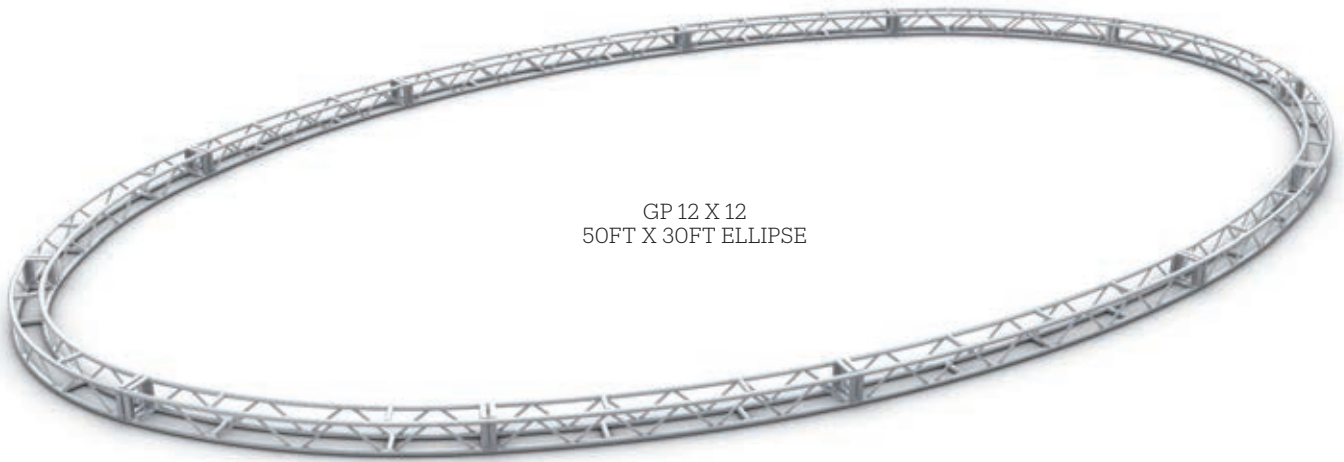

GP 12 X 12
50FT X 30FT ELLIPSE



SUPERTRUSS 12 X 12
28FT 60° STAR



Tower Systems

James Thomas Ground Supported Tower Systems are ideal for outdoor applications, as well as venues where rigging points are unusable or unavailable. Tower components are available in 12"x12", 15"x15", and 20.5"x20.5" profiles, and are capable of lifting a wide range of James Thomas truss products and roof systems.

12" TOWER SYSTEM

The 12" square ground support tower. A system manufactured with the purpose of providing a lifting medium for a variety of Thomas trusses ranging from 12" x 12" to heavy duty truss.



A tower erecting system can also be supplied with 12" tower system at extra cost.

Select the correct sleeve block for the type of truss being used

The towers will provide the necessary equipment to support a truss rig in venues where flying points are either not strong enough, or not in the right place. Each tower is capable of lifting 2 tons to a maximum height of 33 feet. The 2 tons weight must include the self weight of the truss rig and the motors. The truss rig is raised and lowered by means of electric chain hoists. The motor is rigged in the truss and works in double fall due to the chain being passed over the roller beam at the top of the tower. The motor is then connected onto the other side of the sleeve block. Below, we list a brief description of the parts which make up a 12" ground support tower.

The base of the tower has 4 screw jack assemblies with 6" diameter foot pads, which are adjustable to enable leveling of the tower. The base also incorporates 4 ball casters which allows the whole rig to be accurately positioned before the tower is raised. Once the tower system is ready to be raised, all the screw jacks must be adjusted evenly and must take the load off the ball casters.

The hinge section is designed to allow the towers to be assembled horizontally at truss top level before being swung and locked in the vertical operating position.

The tower sections are manufactured from aluminum 6082T6 2" x .157" thick wall tube with 1" x .125" wall diagonals. The tower sections are connected together by Camloc quick release bolts. Once the tower height has been determined, the roller beam is then fitted at the top of the tower.

The roller beam accepts the chain from the chain hoist, which is run over the top of the roller beam and back down to the other side of the sleeve block.

The sleeve block is the interface between the truss rig and the towers. It is designed to create a semi-rigid joint between the truss grid and the towers by using 16 heavy duty 4" wheels to guide the rig up each tower.

The standard 12" tower kit is made up of the following truss elements:

12" Tower

PRODUCT CODE	DESCRIPTION	WT lbs
B4100	Base	52.5
B4101	37.5" Hinge section	46
B3501	78.7" Hinge section	67
B0104	2'6" section	24
B0103	5' section	39.5
B0100	10' section	72.5
B4102	Roller beam	39.5
#	Sleeve block	-

Failure to comply with any load tables, equipment labels, engineering reports; or any warnings, written verbal, or implied, could result in serious injury or death.

In addition to the standard truss elements, a sleeve block is supplied, based on the type of truss being used. The following are available:

PRODUCT CODE	DESCRIPTION	WT lbs
B4108	Heavy duty sleeve block	79
B4104	GP 20.5 x 20.5 sleeve block	75
B4105	GP triangular sleeve block	72.5
B4106	GP 12 x 12 & 18 x 12 sleeve block	70.5
B4103	Pre-rig truss sleeve block	97

Other sizes of tower truss are available should they be required.

PRODUCT CODE	DESCRIPTION	WT lbs
B0101	8' tower section	59.5
B0102	6' tower section	46
B0105	1' 3" tower section	15

Outrigger and Stabilizer sets are required when using less than 3 towers. These are designed to provide stability and rigidity to single or two tower systems.

PRODUCT CODE	DESCRIPTION	WT lbs
B4003	Outrigger arm	19.5



The ground support tower system can be used outside but must be suitably anchored from the top of each tower sleeve block to the ground via a guy wire to a suitable ground anchor. We recommend that the bases are sat on top of a 3' square piece of 3/4" plywood. Should a cover be required then please refer to James Thomas Engineering approved design to suit your requirements.

The ground support tower system can also be specified with lock offs, which provide safety against chain failure. We offer 2 types of lock offs. The first type of lock off is for truss systems that will always be rigged at the top of the towers. The second type is designed to fit in the tower at the desired height, whether the truss is at the top of the tower or not.

PRODUCT CODE	DESCRIPTION	WT lbs
B4110	Tower top truss lock	-
B4120	Adjustable lock off system	-

15" TOWER SYSTEM

The 15" square ground support tower is a system manufactured for the purpose of providing a lifting medium for a variety of Thomas trusses from 20.5" x 20.5", Heavy duty, SuperTruss, and Pre-rig truss to Roof systems.



The towers will provide the necessary equipment to support a truss rig in venues where the flying points are either not strong enough, or not in the right place. Each tower is capable of lifting 4 tons to a maximum height of 40 feet. However, if you use a CM 1 ton hoist, you will only be able to lift 2 tons (ie. block and fall). The 4 ton weight must include the self weight of the truss rig and the motors. The truss rig is raised and lowered by means of electric chain hoists. The motor is rigged in the truss and works in double fall due to the chain being passed over the roller beam at the top of the tower. The motor is then connected onto the other side of the sleeve block. Below, we list a brief description of the parts that make up a 15" ground support tower.

The **base** of the tower has 4 screw jack assemblies with 6" diameter foot pads, which are adjustable to enable levelling of the tower. The base also incorporates 4 ball casters, which allow the whole rig to be accurately positioned before the tower is raised. Once the tower system is ready to

be raised, all screw jacks must be adjusted evenly and must take the load off the ball casters.

The **hinge section** is designed to allow the towers to be assembled horizontally at truss top level before being swung and locked in the vertical operating position. The **tower sections** are manufactured from 6061T6 aluminum 2" x .157" thick wall tube with 1" x .125" wall diagonals. The tower sections are bolted together to allow 30" adjustments in height up to a maximum of 40 feet. Once the tower height has been determined, then the roller beam is fitted at the top of the tower. The **roller beam** accepts the chain from the chain hoist, which is run over the top of the roller beam and back down to the other side of the sleeve block.

The **sleeve block** is the interface between the truss rig and the towers. It is designed to create a semi rigid joint between the truss grid and the towers by using 16 heavy duty 4" wheels to guide the rig up each tower.

Outriggers needed if used in single or double tower configuration.

PRODUCT CODE	DESCRIPTION	WT lbs
B4205	Pre-rig truss sleeve block	97
B4206	Heavy duty sleeve block	79
B4207	20.5" x 20.5" Sleeve Block	75
For SuperTruss refer to each trusses specification sheet		

Standard 15" Tower Parts are:

PRODUCT CODE	DESCRIPTION	WT lbs
B4200	Base	53
B4201	37.5" Hinge section	50
B3801	78.7" Hinge section w/ forks	70.5
B4202	Roller Beam	50
B4203	Rocker Beam	49
B0200	10' section	97
B0201	8' section	90
B0202	5' section	49
B0203	2'6" section	32
#	Sleeve block	-

Failure to comply with any load tables, equipment labels, engineering reports, or any written, verbal, or implied warnings, could result in serious injury or death.

12" SUPERTOWER SYSTEM

The 12" SuperTower square ground support is a system manufactured for the purpose of providing a lifting medium for a variety of Thomas trusses from 20.5" x 20.5", Heavy duty, SuperTruss, and Pre-rig truss to Roof systems. With forked connections, the SuperTower is faster to put together and has a higher load rating than a bolted tower.

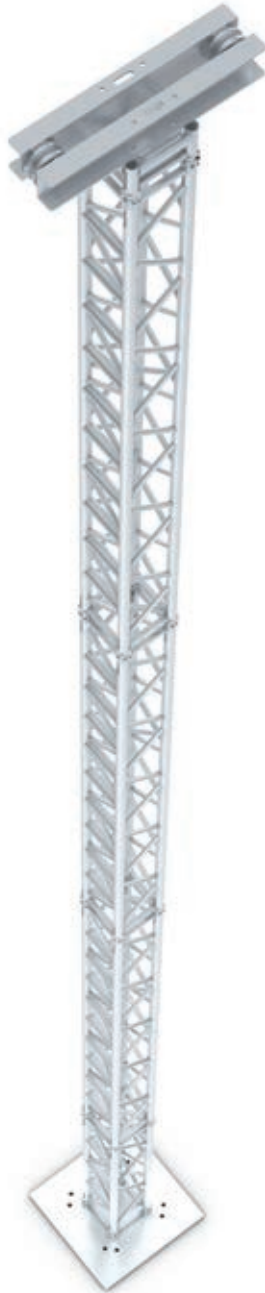

The towers will provide the necessary equipment to support a truss rig in venues where the flying points are either not strong enough, or not in the right place. Each tower is capable of lifting 4 tons to a maximum height of 40 feet. However, if you use a CM 1 ton hoist, you will only be able to lift 2 tons (ie. block and fall). The 4 ton weight must include the self weight of the truss rig and the motors. The truss rig is raised and lowered by means of electric chain hoists. The motor is rigged in the truss and works in double fall due to the chain being passed over the roller beam at the top of the tower. The motor is then connected onto the other side of the sleeve block. Below, we list a brief description of the parts that make up a 15" ground support tower.

The base of the tower has 4 screw jack assemblies with 6" diameter foot pads, which are adjustable to enable levelling of the tower. The base also incorporates 4 ball castors, which allow the whole rig to be accurately positioned before the

tower is raised. Once the tower system is ready to be raised, all screw jacks must be adjusted evenly and must take the load off the ball castors.

The hinge section is designed to allow the towers to be assembled horizontally at truss top level before being swung and locked in the vertical operating position. The tower sections are manufactured from 6061T6 aluminum 2" x .157" thick wall tube with 1" x .125" wall diagonals. The tower sections are pinned together to allow 30" adjustments in height up to a maximum of 40 feet. Once the tower height has been determined, then the roller beam is fitted at the top of the tower. The roller beam accepts the chain from the chain hoist, which is run over the top of the roller beam and back down to the other side of the sleeve block.

The sleeve block is the interface between the truss rig and the towers. It is designed to create a semi rigid joint between the truss grid and the towers by using 16 heavy duty 4" wheels to guide the rig up each tower.

12" SuperTower

PRODUCT CODE	DESCRIPTION	WT lbs
B4100	Base	52.5 lbs
B01S012H	1ft Hinge section	16.09 lbs
B01S036H	3ft Hinge section	29.42 lbs
B4102	Rollerbeam	39.5 lbs
B01S120	10' Section	79.97 lbs
B01S060	5' Section	45.49 lbs
B01S048	4' Section	28.95 lbs
B20-12SP	Tower sleeve plate for 20.5" truss	32 lbs

15" SUPERTOWER SYSTEM

The 15" SuperTower square ground support is a system manufactured for the purpose of providing a lifting medium for a variety of Thomas trusses from 20.5" x 20.5", Heavy duty, SuperTruss, and Pre-rig truss to Roof systems.



With forked connections, the SuperTower is faster to put together and has a higher load rating than bolted tower.

The towers will provide the necessary equipment to support a truss rig in venues where the flying points are either not strong enough, or not in the right place. Each tower is capable of lifting 4 tons to a maximum height of 40 feet. However, if you use a CM 1 ton hoist, you will only be able to lift 2 tons (ie. block and fall). The 4 ton weight must include the self weight of the truss rig and the motors. The truss rig is raised and lowered by means of electric chain hoists. The motor is rigged in the truss and works in double fall due to the chain being passed over the roller beam at the top of the tower. The motor is then connected onto the other side of the sleeve block. Below, we list a brief description of the parts which make up a 15" ground support tower.

The base of the tower has 4 screw jack assemblies with 6" diameter foot pads, which are adjustable to enable levelling of the tower. The base also incorporates 4 ball castors, which allow the whole rig

to be accurately positioned before the tower is raised. Once the tower system is ready to be raised, all screw jacks must be adjusted evenly and must take the load off the ball castors.

The hinge section is designed to allow the towers to be assembled horizontally at truss top level before being swung and locked in the vertical operating position. The tower sections are manufactured from 6061T6 aluminum 2" x .157" thick wall tube with 1" x .125" wall diagonals. The tower sections are pinned together to allow 30" adjustments in height up to a maximum of 40 feet.

Once the tower height has been determined, then the roller beam is fitted at the top of the tower.

The roller beam accepts the chain from the chain hoist, which is run over the top of the roller beam and back down to the other side of the sleeve block. The sleeve block is the interface between the truss rig and the towers. It is designed to create a semi rigid joint between the truss grid and the towers by using 16 heavy duty 4" wheels to guide the rig up each tower.

15" SuperTower

PRODUCT CODE	DESCRIPTION	WT lbs
B4200	Base	52.5
B02S66H	66" hinge section - 2 pieces	B01S012H
B01S036H	3' hinge section	B01S036H
B02SRB1	Rollerbeam extended	B4102
B02S120	10' Section	B01S120
B02S084	7' Section	47.23 lbs
B02S060	5' Section	B01S048
B02S048	4' Section	
B02S036	3' Section	
B20-15SP	Tower sleeve plate for 20.5" truss	
B1409B	Tower sleeve plate for pre-rigged SuperTruss	

20.5" SUPERTOWER SYSTEM

The 20.5" SuperTower is a system manufactured with the purpose of providing a lifting medium for a variety of Thomas trusses ranging from 12" x 12" to 30" x 30" Super-Mega.



The towers will provide the necessary equipment to support a truss rig in venues where the flying points are either not strong enough, or not in the right place. Each tower is capable of lifting over 6 tons to a maximum height of 65 feet. The 6 ton weight must include the self weight of the truss rig and the motors. The truss rig is raised and lowered by means of electric chain hoists. The motor is rigged in the truss and works in double fall due to the chain being passed over the roller beam at the top of the tower. The motor is then connected onto the other side of the sleeve block. Below, we list a brief description of the parts which make up a ST20.5" ground support tower. The base of the tower has 4 screw jack assemblies with 6" diameter foot pads, which are adjustable to enable leveling of the tower. The base also incorporates 4 ball castors, which allow the whole rig to be accurately positioned before the tower is raised. Once the tower system is ready to be raised, all screw jacks must be adjusted evenly and must take the load off the ball castors. The hinge section is designed to allow

the towers to be assembled horizontally at truss top level before being swung and locked in the vertical operating position. The tower sections are manufactured from 6061T6 aluminum 2" x .157" thick wall tube with 1" x .125" wall diagonals. The tower sections are connected together by double ended spigoted connectors. The modular tower sections allow 30" adjustments in height. Once the tower height has been determined, then the roller beam is fitted at the top of the tower.

The roller beam accepts the chain from the chain hoist, which is run over the top of the roller beam and back down to the other side of the sleeve block.

The sleeve block is the interface between the truss rig and the towers. It is designed to create a semi-rigid joint between the truss grid and the towers by using 16 heavy duty 4" wheels to guide the rig up each tower. Outrigger arms are required when not used in a 4-post grid configuration designed to create a semi rigid joint between the truss grid and the towers by using 16 heavy duty 4" wheels to guide the rig up each tower.

20.5" SuperTower

PRODUCT CODE	DESCRIPTION	WT lbs
B5200-STEEL	Base	159.1
B20T036H	3.67' Hinge section	29.3
B20T060	5' section	30.9
B20T096	8' section	49.4
B20T060	5' section	39.5
B0T120	10' section	72.5
B20T-RB	Roller beam	39.5
#	Sleeve block	-

A tower erecting system can also be supplied with the 20.5" tower system at extra cost.

Ballast Base B4209 can be attached directly to the tower to provide ballast weight.

Select the correct sleeve block for the type of truss being used

SUPERMEGA TOWER 30 × 30

In line with our other SuperMega products, James Thomas Engineering has produced a 30" x 30" tower. This diverse product can be used either as a tower or as truss. It is built for applications requiring heavy loading and/or height capabilities. Made from 6061T6 alloy, the truss has 3" OD x 1/4" main chords and 2" x 0.157" diagonal tubes.



Tower: When the desired working load is 13,000 pounds, this single tower can be a maximum height of 56' with the appropriate anchorage base plate. As a goal post, the maximum height will be 73' and when used as a corner in a 4 post grid 110' (both with the appropriate anchorage base plate). When the desired

working load is 26,000 pounds, this single tower can be a maximum of 40' with the appropriate anchorage base plate. As a goal post, 54' will be the maximum height and when used as a corner in a 4 post grid 81' (both with the appropriate anchorage base plate).

SUPERMEGA TOWER 30x30

PRODUCT CODE	DESCRIPTION	WT lbs
B31240	20' Section	378
B31144	12' Section	227
B31120	10' Section	189
B31096	8' Section	162
B31060	5' Section	126
B3100	60° corner gate	-
B3101	90° corner gate	-
B3102	120° corner gate	-
B3103	135° corner gate	-
B3104	3 way gate	31
B3105	3 way gate with lifting point	-
B3106	Sleeve Block (30" tower)	341

LOADING FIGURES show maximum loads between supports in addition to self weight of truss. * Denotes load limited to suit maximum shear capacity. All loads include 20% overload factor for dynamic effects.



TOWER ACCESSORIES

Outriggers are designed to provide stability and rigidity to any James Thomas Engineering Tower system. Outriggers are required when using less than three towers in a temporary system. Please rely on your engineering documents to determine when and where to safely use outriggers.

Small Outrigger arm suitable for all tower systems P/N B4003 19.5 lbs.



Small Outrigger arm suitable for all tower systems P/N B4003 19.5 lbs.

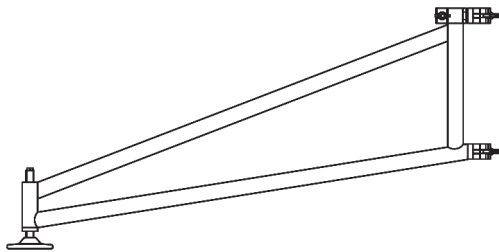

Outrigger arms are required when using less than 3 towers. These are designed to provide stability and rigidity to single or 2 tower systems.

Adjustable Outrigger suitable for all tower systems P/N B4003B

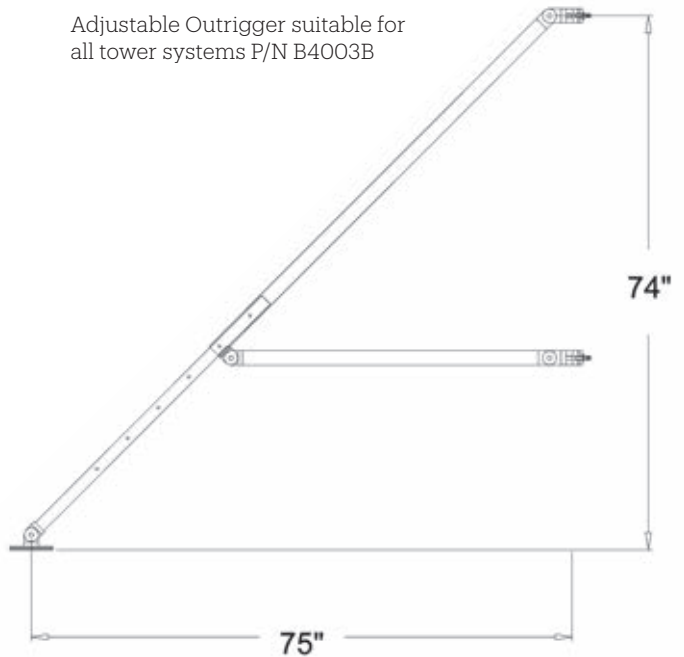

The Tower Lifting System is a device fitted to the sleeve block with 2 diagonal braces which clamp on to the horizontal truss to enable the tower to be raised or lowered safely using the chain motor. The chain hoist is rigged in the lifting point and the hoist chain is passed over the lifting system pulley and then around the Roller Beam and fixed to the top of the hinge section. The tower is raised by using the chain hoist to pull up on the tower. Caution should be used to not pull the tower over when the tower is near vertical.

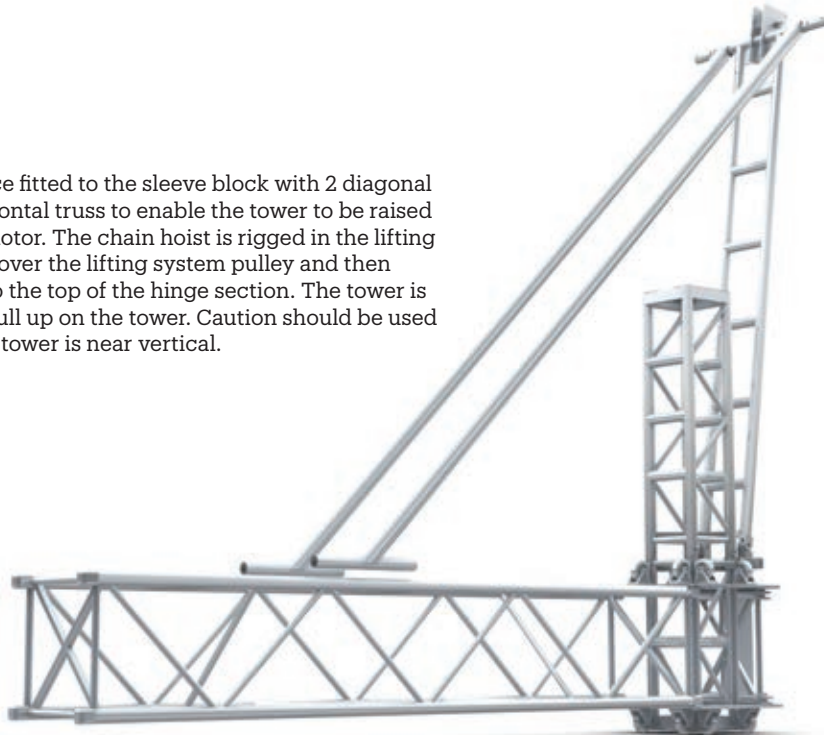

PRODUCT CODE	DESCRIPTION	WT lbs
B4250	Tower Lifting System	38
B4003	Small Outrigger arm	19.5
B4003B	Large Outrigger	-

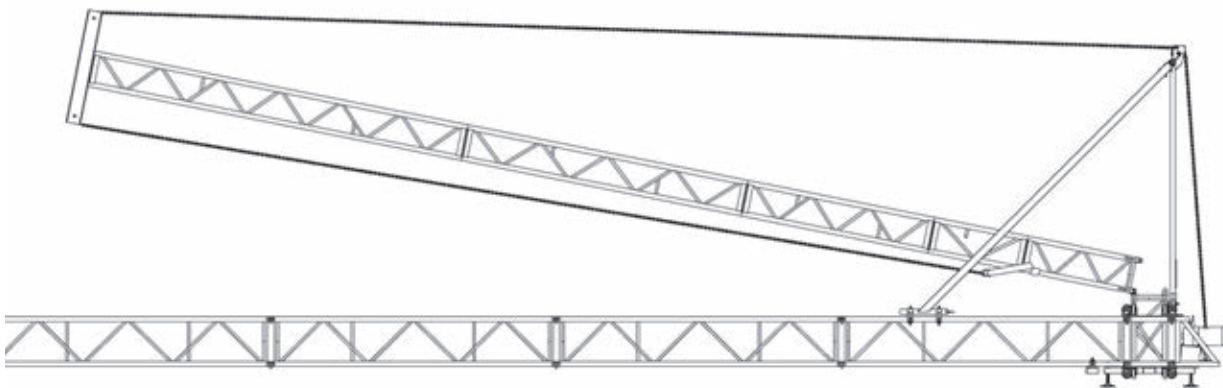

The ground support tower system can be used outside but must be suitably anchored from the top of each tower sleeve block to the ground via a guy wire to a suitable ground anchor. We recommend that the bases are placed on top of a 3' square piece of 3/4" plywood. Should a cover be required, please refer to James Thomas Engineering for an approved design to suit your requirements.

The ground support tower system can also be specified with lock offs, which provide safety against chain failure. We offer 2 types of lock offs. The first lock off is for truss systems that will always be rigged at the top of the towers. The second type of lock off is designed to fit in the tower at the desired height, whether the truss is at the top of the tower or not.

BASE PLATES

The James Thomas Engineering B4209 Ballast Base attaches to our standard 12x12, 12x18, and 15x158 b4200 tower bases, as well as to our bigger 20.5x20.5 B5200 series tower bases. The B4209 is made of steel, can be hand lifted at the corners, fork entries are also built into all four sides for quicker transport. This base attachment features the same adjustable feet as the tower base to ensure the pad is level. It can be ground stacked while mounted on the base or used on its own as a ballast weight. Our Ballast Base container holds up to 3,000 lbs of water weight in a steel reinforced, UV stabilized polymer enclosure protected by a double-layer liner, lockable lid and can be stacked 3 high for a total filled weight of 9,000 lbs.

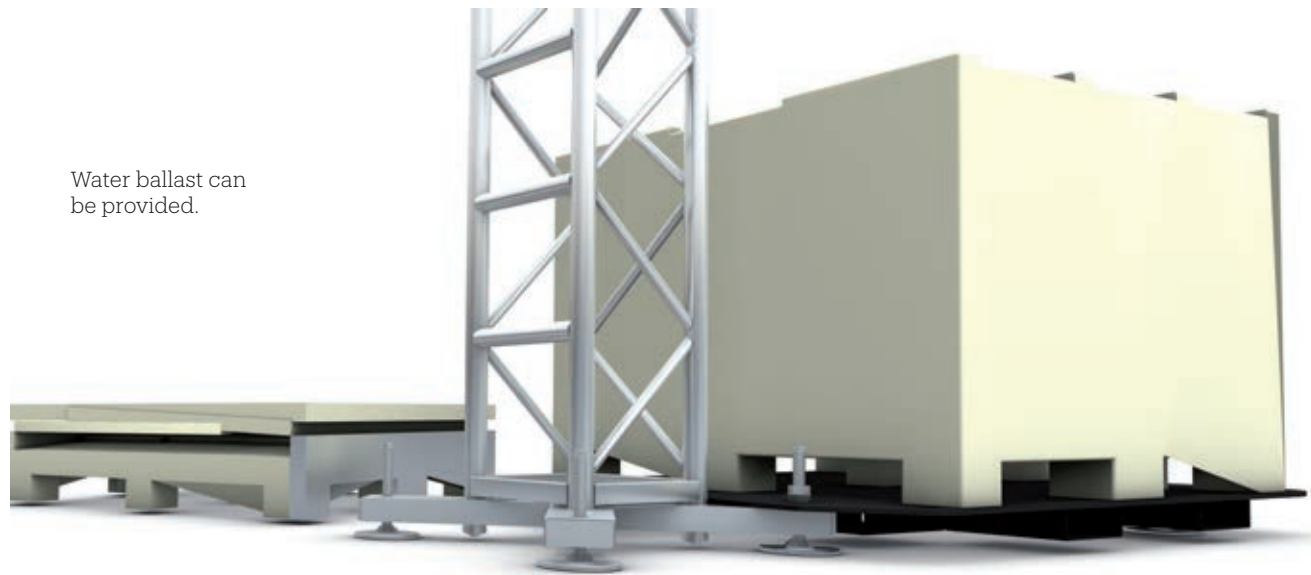

Water ballast can be provided.

PRODUCT CODE	DESCRIPTION	WT lbs
B4209	Ballast Base Assembly	525
B4209-CONT	Ballast Weight Container	225
B4209-BRIDGE	Container Fill Bridge	6
B4209-LIN	Double Layer Liner	4.5
B4209-CAP	Tamper Evident Drain Cover	0.2
FA1HN	Hex Nut (Base Attachment)	-
FA1FN	Washer (Base Attachment)	-
P6578 R2	Screw Jack Top Hat	-
GO150-Z	9" Threaded Screw Jack	-
GO151-Z	Base Pad	-
GO152	Base Pad Bolt Set	-
GO153B	Base Hat Bolt Set	-

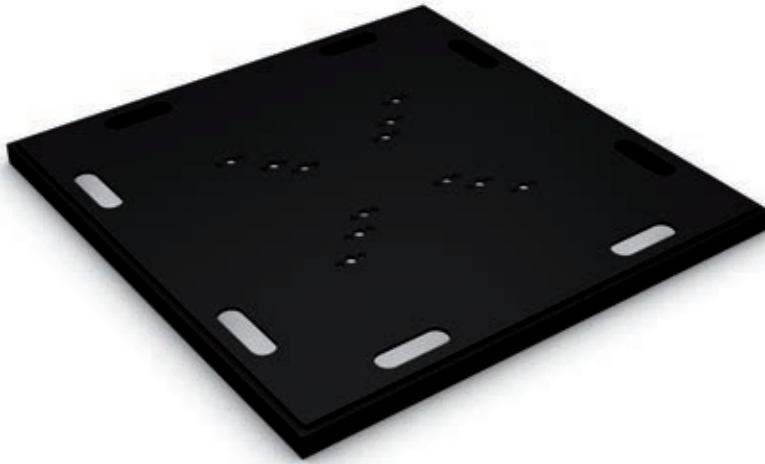

James Thomas Engineering 18645-01 36" x 36" steel floor base is standard for indoor use. This powder-coated base fits truss sizes 12x12, 12x18, 15x15, and 20.5x20.5 towers. Nut-plates allow users to easily attach the truss without flipping the plate. Hand cut outs allow for easier mobility.

Weight (lbs) 115 lb

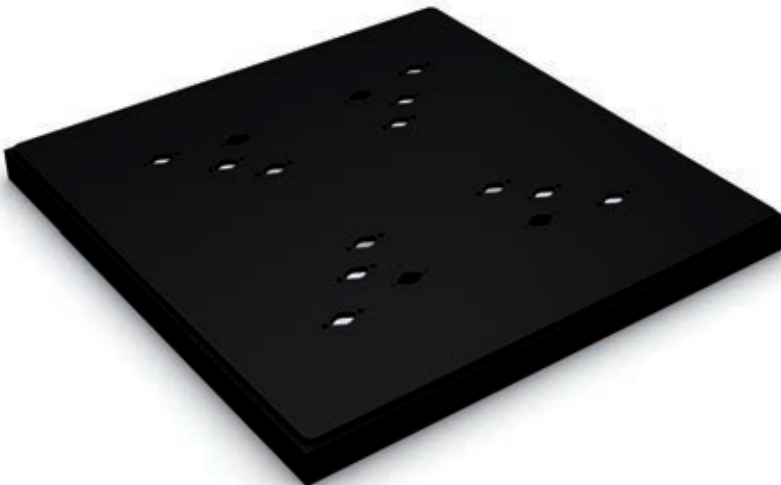

James Thomas Engineering B4620 24" x 24" steel floor base is standard for indoor use. This powder-coated base fits truss sizes 12x12, 12x18, 15x15, and 20.5x20.5 towers. Nut-plates allow users to easily attach the truss without flipping the plate.

Weight (lbs) 59 lb

Audio Towers

James Thomas Engineering Audio Towers provide high quality construction others only try to duplicate.





PLBR Roof System
with Sound Wings

MINI TAT

Following the success of the 20.5" TAT system, James Thomas Engineering introduces the Mini TAT. The Mini TAT is constructed with a 12" SuperTower. It can support loads of 1500 lbs at 30' and loads of 1850 lbs at 20'. Rear base legs are optional. This is a great addition for audio companies and rental houses. But don't let your imagination stop there! Audio isn't the only equipment the tower can support. The 12" version is designed with the smaller line array systems in mind.

- Easily Transported in Small Trucks
- Low user labor cost for load in and set up
- Minimum installation tools required
- Uses many JTE standard parts that may already be in your inventory

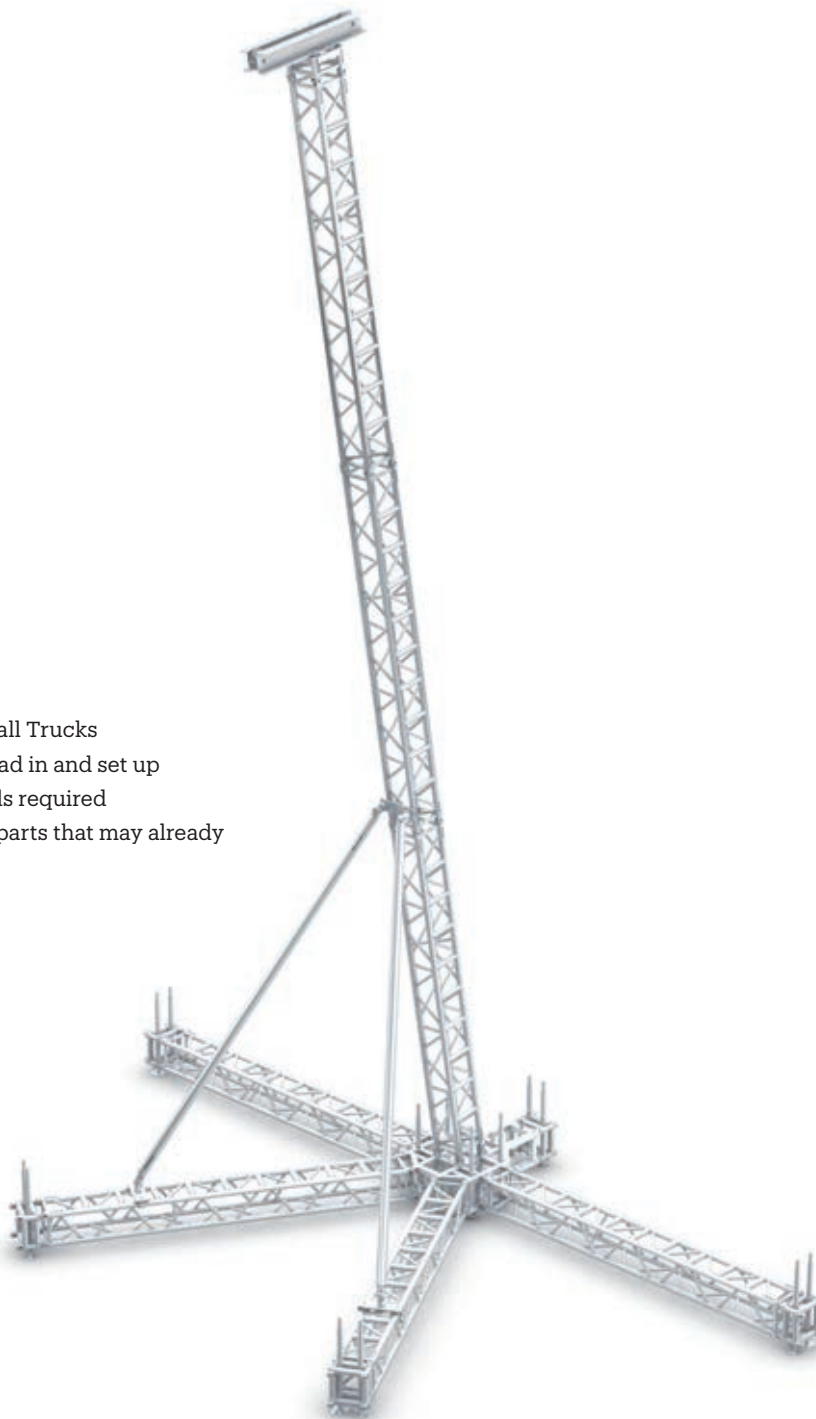

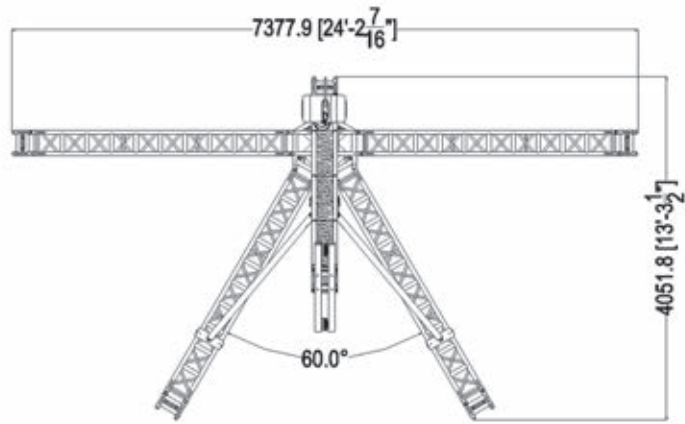

Plan View

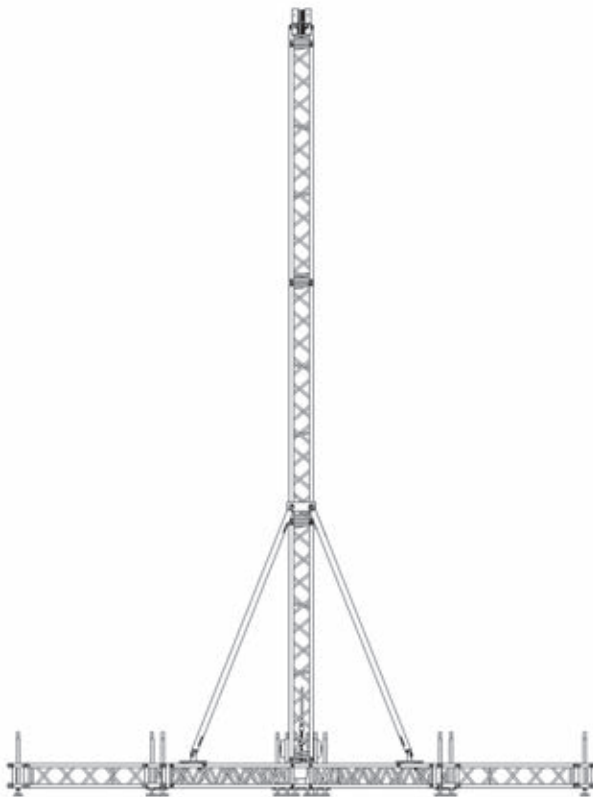

Front Elevation

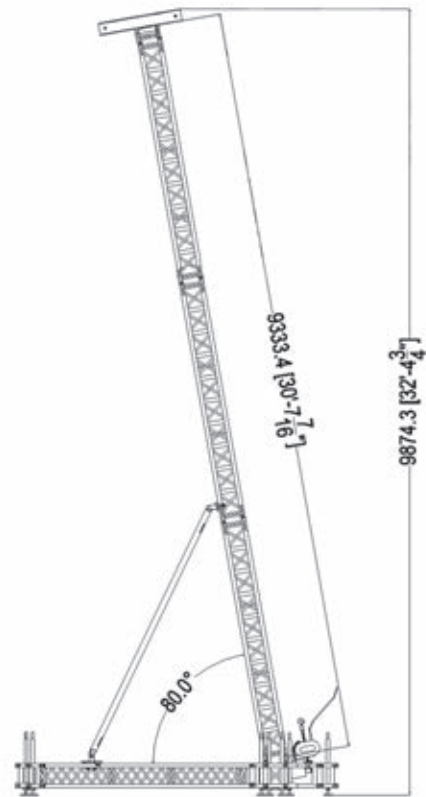

Side Elevation

TAT

James Thomas Engineering continues their tradition of providing the highest quality, most reliable products with the TAT system. TAT is constructed with a 20.5" SuperTower and has a load limit of 2700 lbs. The TAT is also equipped with a base that can accept 2 additional sections of tower for added lateral stability or can be used in the traditional "V" configuration. All parts are constructed of high quality 6061T6 aluminum with the exception of the leveling jacks, which are made of steel.



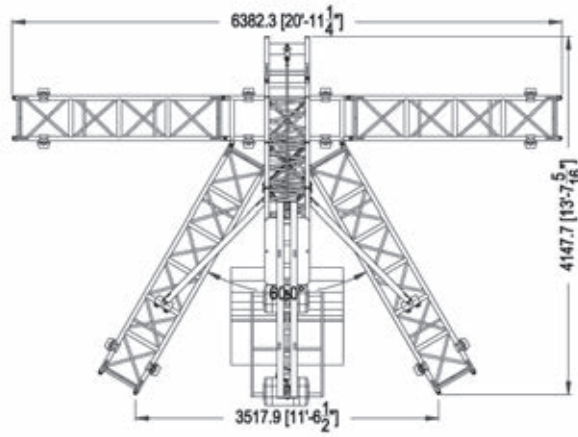

Plan View

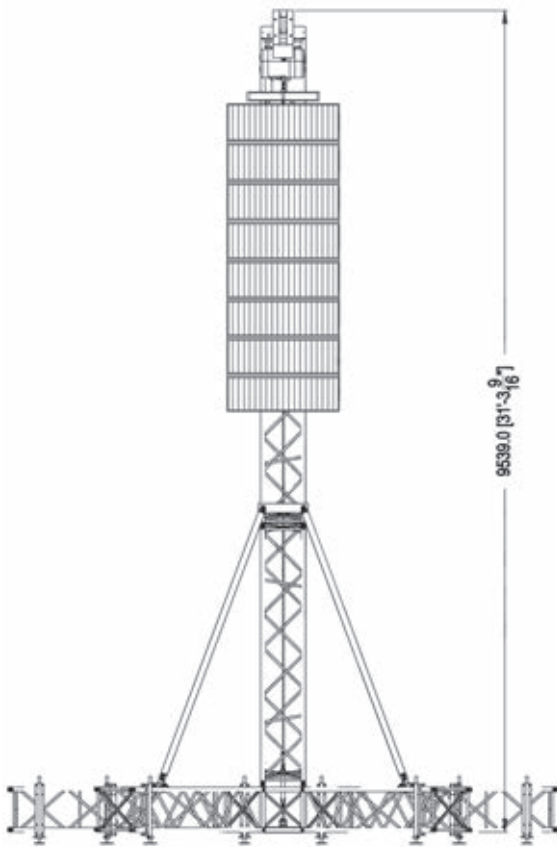

Front Elevation

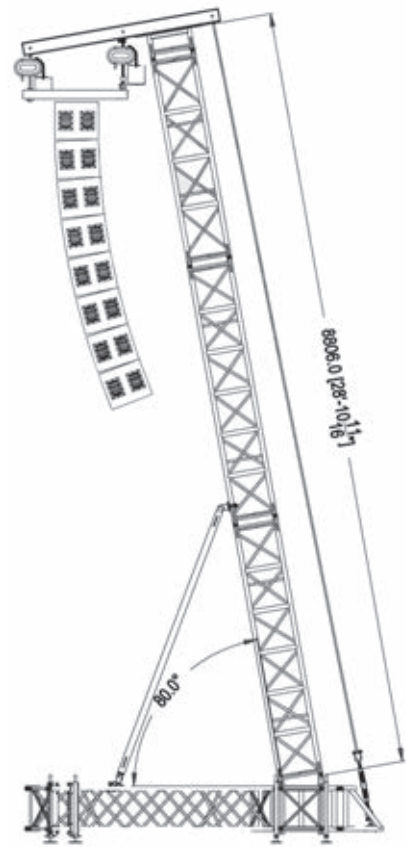

Side Elevation



Rigging Hardware & Truss Accessories

As well as manufacturing our own hardware and accessories, James Thomas Engineering partners with the industry's most well known brands to supply customers with reliable rigging products.

PROPLUS FALL ARREST KITS



WAIST SIZE:	
XX-Small	(24-32")
X-Small	(28-34")
Small	(32-40")
Medium	(36-44")
Large	(40-48")
X-Large	(44-52")

All sizes compatible with all fall arrest kits.



ProPlus™ Basic Fall Arrest Kit

THE RIGGER'S KIT INCLUDES:
(1) ProPlus™ Basic Harness
(1) ProPlus™ 6' Elastic Lanyard
(1) ProPlus™ Draw String Bag
(1) T-Shirt
(1) ProPlus™ Manual



ProPlus™ Basic Fall Arrest Kit

KIT INCLUDES:
(75') 1/2" KMIII Rope
(1) ProPlus™ Basic Harness with Bayonet Buckle
(1) 6' Lanyard Single Leg Elastic with oversized snaps
(1) Red Petzl Vertex Helmet
(1) Black Anodized Single Pulley 2" x 1/2"
(1) Roundsling Purple with black cover 3'
(1) ProPlus Carabiner
(1 pr) Safety Utility gloves
(1) Drawstring Bag
(1) T-Shirt
(1) ProPlus Manual



ProPlus™ Technician Kit

KIT INCLUDES:
(1) ProPlus™ Technician Harness
(1) ProPlus™ 6' Elastic lanyard
(1) Red Petzl Vertex Helmet
(1pr) Safety Utility gloves
(1) ProPlus™ Manual
(1) ProPlus™ T-Shirt
(1) ProPlus™ Drawstring bag

RETRACTABLE LIFELINES

ProPlus Retractable life lines

ProPlus Lanyards, Harnesses and Lifelines are available upon request.

ProPlus™ Self Retracting Lifeline 25'



The ProPlus™ Self Retracting Lifeline has a cast aluminum housing and features a dual internal inertia braking system. Comes with 25' of galvanized aircraft cable and a carabiner for attachment to an anchorage point.

The ProPlus™ Self Retracting Lifeline is perfect for short ladders to galleries and catwalks, and for side boom and cove lighting positions.

ProPlus™ Self Retracting Lifeline 50'



The ProPlus™ Self Retracting Lifeline has a cast aluminum housing and features a dual internal inertia braking system. Comes with 50' of galvanized aircraft cable and a carabiner for attachment to an anchorage point.

The ProPlus™ Self Retracting Lifeline is perfect for grid access, ladders, truss access, and wire rope ladders.

ProPlus™ Mini 8' Self Retracting Lifeline



LOCKING HOOK

Material: Steel

3/4" Gate Opening

CARABINER:

1" Gate Opening

2 stage forged steel

Housing Size: 4" x 3" x 4"

Housing Material: Synthetic

ProPlus™ Self Retracting Lifeline 25'



The ProPlus™ Self Retracting Lifeline has a cast aluminum housing and features a dual internal inertia braking system. Comes with 100' of galvanized aircraft cable and a carabiner for attachment to an anchorage point.

The ProPlus™ Self Retracting Lifeline is perfect for access to loading bridge, grids and catwalks. It can also be mounted to the grid and used to protect technicians in personnel lifts on the stage below.

CLAMPS

James Thomas Engineering partners with The Light Source to bring customers the most innovative products. Light Source Mega-Clamps have shipped all over the world.



Mega-Claw Aluminum Finish

Safe Vertical Working Load (lbs) 1,100 lb



Mega-Claw Black Anodized

Safe Vertical Working Load (lbs) 1,100 lb



Mega-Coupler 1/2" Hex Head Bolt With Steel Wing Nut Silver

Safe Vertical Working Load (lbs) 600 lb



Mega-Coupler 1/2" Hex Head Bolt With Steel Wing Nut Black Anodized

Safe Vertical Working Load (lbs) 600 lb



Mega-Coupler, Swivel Silver

Safe Vertical Working Load (lbs) 1,100 lb



Mega-Coupler, Swivel Steel Wing Nut Black Anodized

Safe Vertical Working Load (lbs) 600 lb



Mega-Coupler, 90 Degree Fixed Silver

Safe Vertical Working Load (lbs) 600 lb



Couplers for 2" Pipe & Larger

Safe Vertical Working Load (lbs) 1,100 lb

The MLSM3TO2 fits 3"OD Tube to 2"OD Tube in a swivel configuration. Many different size combinations are available.



Coupler with Eye Nut, Silver

Safe Vertical Working Load (lbs) 1,100 lb

GRAB BARS

James Thomas Engineering Grab bars are manufactured to easily fit Thomas truss. All hardware is included



B07-ADP



B04-ADP

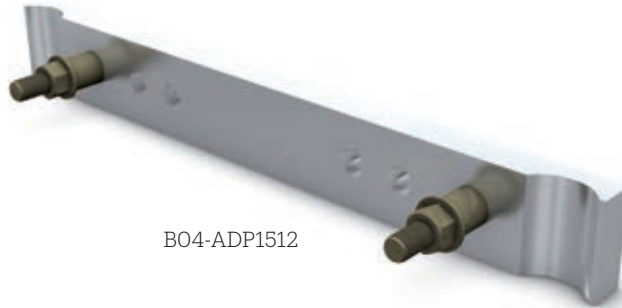

B04-ADP1512

PART NUMBER	DESCRIPTION	WT lbs
B07-ADP	12" Grab bar	4
B04-ADP	20.5" Grab bar	6
B04-ADP1512	20.5" Grab bar that attaches to 15" and 12" truss	6

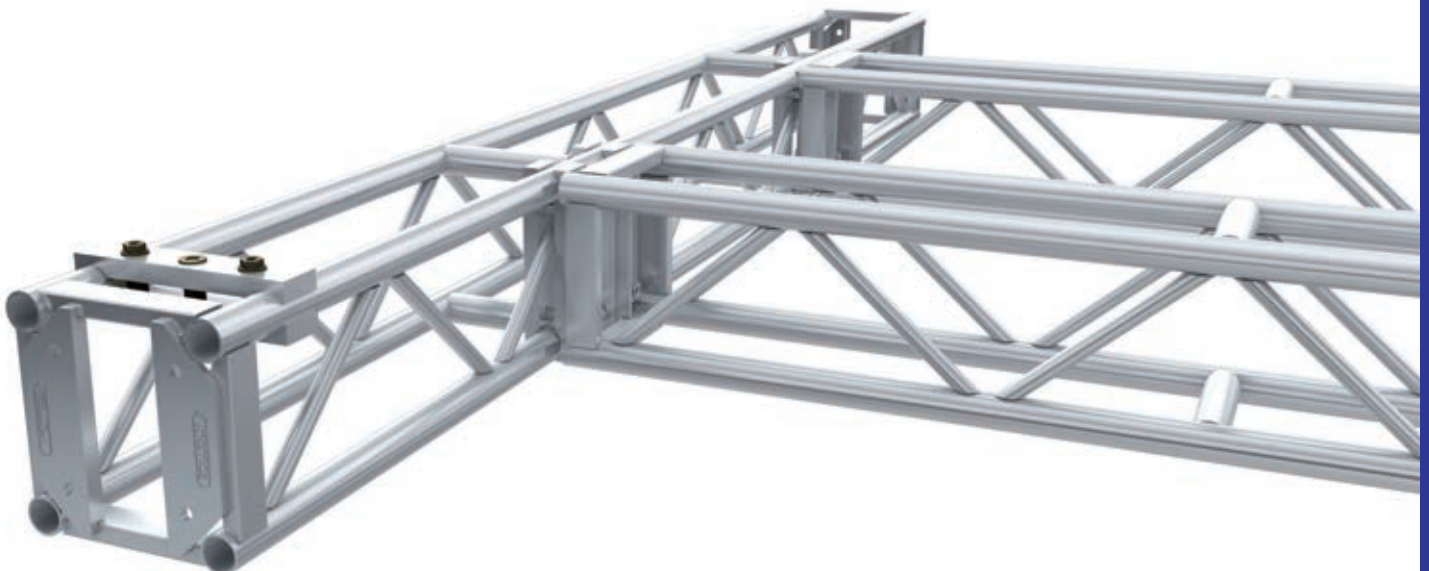

TRUSS LIFTING POINTS

Truss Lifting Points are designed to provide a “hard” attachment to trusses as an alternative to synthetic round slings. The Lifting Points are designed to be attached under the bottom or top chords of a truss. Lifting Points are rated for 2000 pounds and available for 12”, 15”, 18”, 20.5” and 30” Pre-rigged truss. Custom Lifting Points are also available.



B1212



B2312

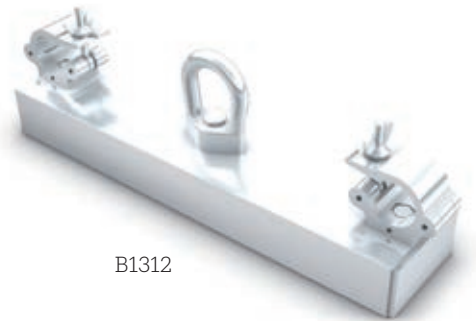

B1312

PRODUCT CODE	DESCRIPTION
B1212	Lifting Point for 12" Truss
B2312	Lifting Point for 18" Truss
B1512	Lifting Point for 15" Truss
B1312	Lifting Point for 20.5" Truss
B1413	Lifting Point for 30" Pre-rigged Truss



12"



18"



20.5"



30" PRT

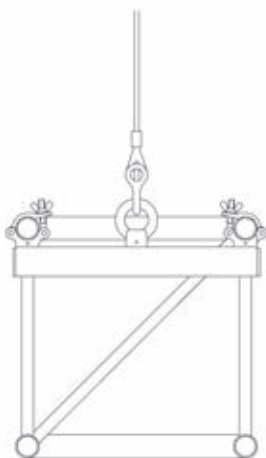

20.5" Lifting Point mounted to top chords

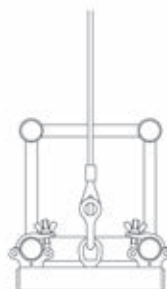

12" Lifting Point mounted to bottom chords

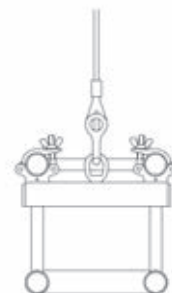

12" Lifting Point mounted to top chords



MEAT RACKS

The Meat Rack is designed to carry lighting bars and is manufactured from 1 1/2" Aluminum box. The Meat Rack is built for robustness with caster wheels around the base for ease of mobility. The frame is aluminum and has a wooden floor and roof (the meat rack is unpainted). Standard items are listed below. Other sizes to suit specific requirements can also be manufactured.



8 Bar adjustable meat rack for 60" lighting bars. Diagrams below show meat rack with lighting bars in storage position.

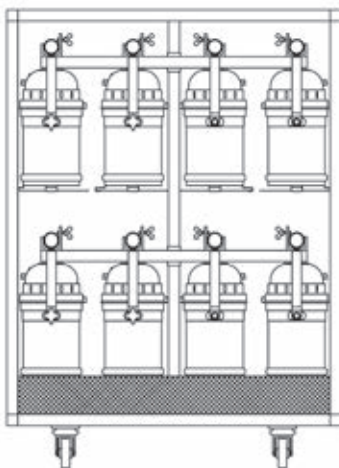

End view

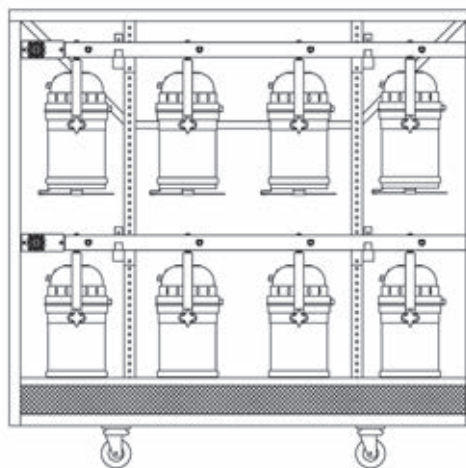

Side view

PRODUCT CODE	DESCRIPTION	Length inches	Width inches	Height inches	Notes
C0401-AL	4 Bar adjustable meat rack for 90" bars	91	30	65	All weights are approximate.
C0461-AL	4 Bar adjustable meat rack for 60" bars	61	30	65	
C0801-AL	8 Bar adjustable meat rack for 90" bars	91	45	65	All measurements are rounded up.
C0861-AL	8 Bar adjustable meat rack for 60" bars	61	45	65	
C1201-AL	12 Bar adjustable meat rack for 90" bars	91	45	92	

SPOT CHAIRS



Universal mount or rotating Spot Chairs

- Top mount, Universal mount or Rotating Spot Chairs available
- Seat belt provided
- Top and universal mount Spot Chairs contain removable 15-3/4" X 20-3/4" Ballast Trays
- Spot mount provided
- Swivel couplers available separately
- Universal mount Spot Chair has removable halo section
- Rotating Spot Chair is under hung only

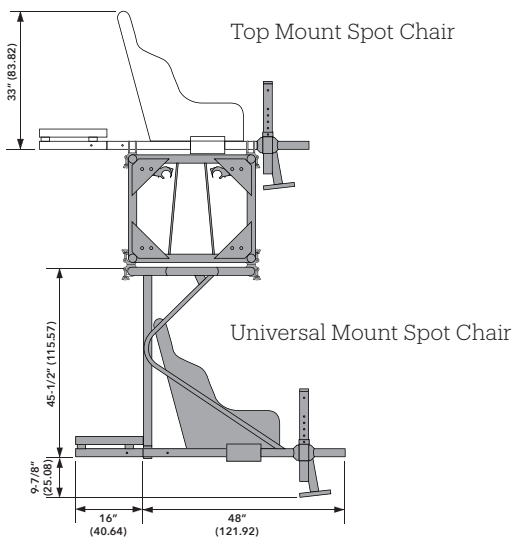

SPOT CHAIRS		
Follow Spot Chairs - do not include swivel couplers to mount chair to trussing. Specify Spot Type when ordering.		
PRODUCT DESCRIPTION	ITEM CODE	Weight lbs
Top mount spot chair	TC ACC-SCTOP	*43
Universal mount spot chair	TC ACC-SCUNI	*71
Rotating spot chair	TC ACC-SC360	*165
* includes seat.		

Roof Systems

James Thomas Engineering Roof Systems have become an industry standard ranging from our Light Weight roofs to our Performance Load-Bearing Roofs. No matter your needs, we have you and your event covered.





PLBR Busch Gardens

ROOF SYSTEMS

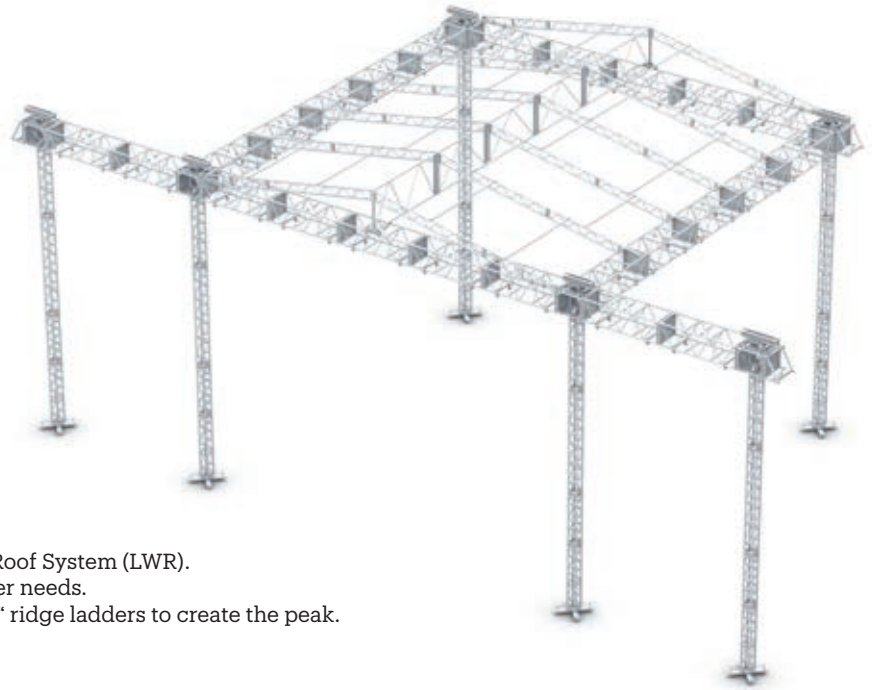

James Thomas Engineering Light Weight Roof System (LWR).
Any size roof is available based on customer needs.
Thomas LWRs use 12" apex ladders and 48" ridge ladders to create the peak.

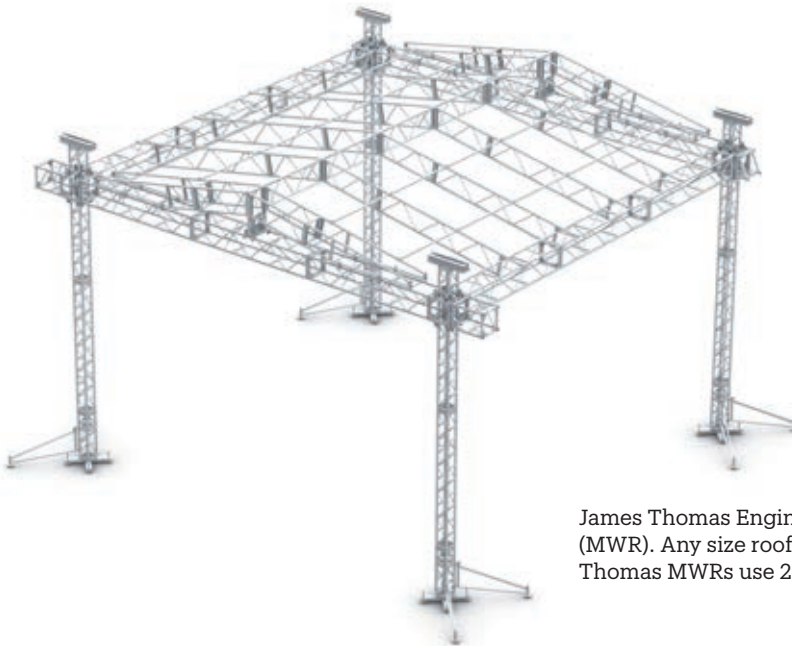

James Thomas Engineering Medium Weight Roof System (MWR). Any size roof is available based on customer needs.
Thomas MWRs use 20.5" ladders to create the peak.

Failure to comply with any load tables, equipment labels, engineering reports; or any written, verbal, or implied warnings, could result in serious injury or death.

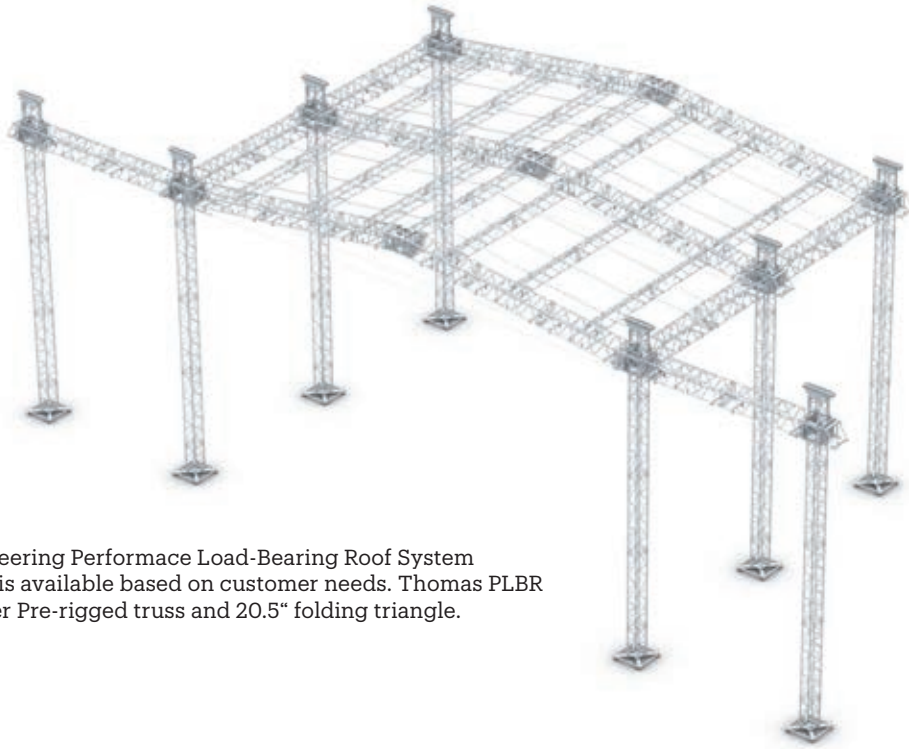

James Thomas Engineering Performace Load-Bearing Roof System (PLBR). Any size roof is available based on customer needs. Thomas PLBR peaks consist of Super Pre-rigged truss and 20.5" folding triangle.

*Denotes load limited to suit maximum shear capacity.
 +Denotes load limited to suit maximum deflection = 1/160

Hoists & Controllers

James Thomas Engineering offers several options for hoists and controllers to ensure customers have the products that are right for their project.

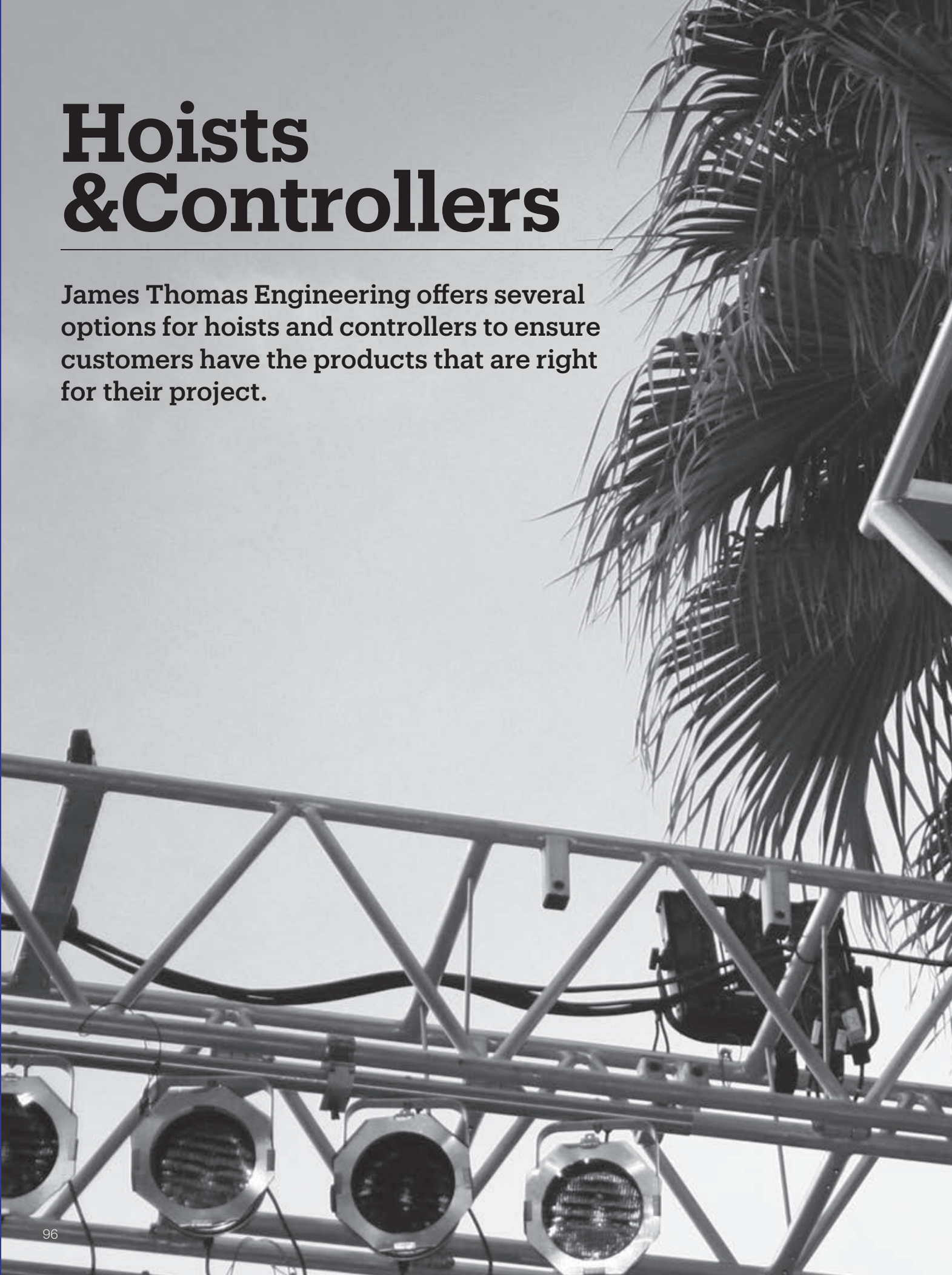



HOISTS

CM Prostar series

Lightweight, quiet and portable. The CM Prostar is designed and built for the unique rigging needs encountered at small venues. Featuring an overload device that protects the hoist, operator and structure from damaging overloads.

SPECIFICATIONS

- Capacities: 300 to 1000 LBS
- Lift: 60 feet standard
- Speeds: 8 to 40 feet/minute
- Voltages: Single & 3-phase available

KEY FEATURES

- **DC Electro-Mechanical double brakes**
Non-adjusting for low maintenance and quiet operation
- **Gearing**
Precision machined gears heat treated for strength and durability
- **Chain guide**
One piece jam free for smooth operation
- **Housing**
Lightweight, cast aluminum, durable and tough black powder coated finish for low visibility
- **Lift wheel**
CM patented 10 pocket oblique lift wheel for quiet and smooth operation
- **Low voltage control**
110 Volt for long cable runs without voltage drop
Optional 24 and 48 volt versions
- **Duty cycle**
H-4 duty rated, designed for heavy duty applications

STANDARD FEATURES

- **Overload protection**
Helps prevent lifting of dangerous overloads
Mounted on Load Chain to prevent over-travel
- **Metric rated**
- **Load chain**
Designed and manufactured by Columbus McKinnon
Zinc plated against corrosion
Optional black phosphate finish
- **The Industry's best lifetime warranty**
- **Meets or exceeds world standards**

OPTIONAL FEATURES

- **Chain bag**
Easy-to-mount cloth type bags
- **Double brake**
- **Encoder**



Specifications

Capacity	NUMBER OF chains	motor hp	lift speed (FPM)	WT. LESS LESS CHAIN (LBS)	WEIGHT 1FT OF CHAIN (LBS)	FULL LOAD AMPS	
						1-PHASE	3-PHASE
300	1	1/6	16	28	.35	3.6	.6* / 1.2**
300	1	1/6	16	28	.35	-	.6* / 1.1**
500	1	1/6	16	28	.35	-	.7* / 1.2**
500	1	1/6	12	28	.35	4	-
600	2	1/6	8	36	.7	3.6	.6* / 1.1**
600	2	1/6	8	36	.7	3.6	.6* / 1.1**
1000	2	1/6	8	36	.7	-	.7* / 1.2

*415 Volt operation ~220 Volt operation

DIMENSIONS		
DRAWING LEGEND	REEVING	
	SINGLE	DOUBLE
A	11"	12-1/8"
B	2-15/16"	3-1/2"
C	2-7/8"	2-3/8"

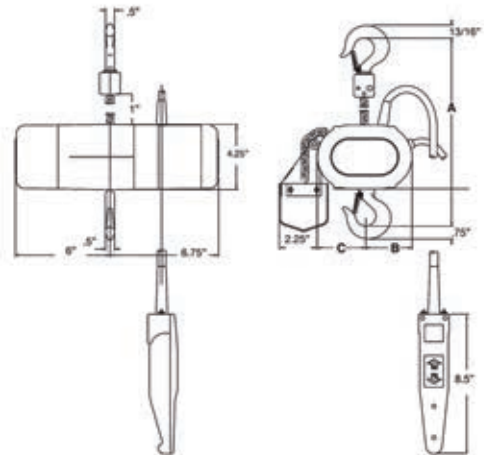

Specifications

MODELS (LBS)	LIFT SPEED (FPM)	OPERATING VOLTAGE			
		SINGLE PHASE		THREE PHASE	
300	16	115 - 1 - 50/60	220 - 1 - 50/60	220 - 3 - 50/60	415 - 3 - 50/60
300	24	-	-	220 - 3 - 50/60	415 - 3 - 50/60
300	40	-	-	220 - 3 - 50/60	415 - 3 - 50/60
500	12	115 - 1 - 50/60	220 - 1 - 50/60	-	-
500	16	-	-	220 - 3 - 50/60	415 - 3 - 50/60
500	20	-	-	220 - 3 - 50/60	415 - 3 - 50/60
600	8	115 - 1 - 50/60	220 - 1 - 50/60	-	-
600	12	-	-	220 - 3 - 50/60	415 - 3 - 50/60
1000	6	115 - 1 - 50/60	220 - 1 - 50/60	-	-
1000	8	-	-	220 - 3 - 50/60	415 - 3 - 50/60
1000	12	-	-	220 - 3 - 50/60	415 - 3 - 50/60

HOISTS

CM Lodestar series



DRAWING LEGEND	DIMENSIONS		
	LODESTAR MODELS		
	B, C, F	J, JJ, L, LL	R, RR
A	16.20"	18.5625"	24.125"
B	6.08"	7.62"	7.62"
C	.67"	.875"	1.125"
D	11.80"	10.03"	10.03"
F	8.94"	13.01"	13.01"
H	1"	1.1875"	1.5"
I	4.46"	6.93"	5.57"
J	4.22"	5.69"	7.05"
M	1"	1.125"	1.3125"
P	6.62"	8.22"	8.22"

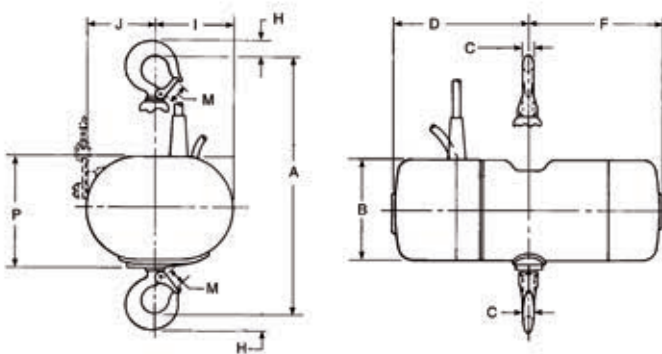

Specifications

MODEL	Rated load ton*	lifting speed (FPM)	motor hp	operating voltage**	full load	work rating		reeving	protection class	noise level	lift (Feet)**
						HMI	FEM				
B	1/4	16	1/4	230/460 - 3 - 60	1.8/1.1	H4	2M+	1	IP54	73 dB	60
C	1/4	32	1/2	230/460 - 3 - 60	2.2/1.3	H4	2M+	1	IP54	73 dB	60
F	1/2	16	1/2	230/460 - 3 - 60	2.2/1.3	H4	2M+	1	IP54	73 dB	60
J	1/2	32	1	230/460 - 3 - 60	3.7/2.2	H4	2M+	1	IP54	73 dB	60
JJ	1/2	64	2	230/460 - 3 - 60	7.9/5.0	H4	2M+	1	IP54	73 dB	60
L	1	16	1	230/460 - 3 - 60	3.7/2.2	H4	2M+	1	IP54	73 dB	60
LL	1	32	2	230/460 - 3 - 60	7.9/5.0	H4	2M+	1	IP54	73 dB	60
R	2	8	1	230/460 - 3 - 60	3.7/2.2	H4	2M+	2	IP54	73 dB	60
RR	2	16	2	230/460 - 3 - 60	7.9/5.0	H4	2M+	2	IP54	73 dB	60



Custom Arched LWR
with Sound Wings
Aspen, Colorado



HOISTS

2-TON SINGLE-REEVED

The CM® entertainment Lodestar® is now available as an economical 2-ton, single-reeved unit that's ideal for a variety of lifting applications. And, because it's a single-reeved unit, overall weight is decreased making it easier to transport and rig compared to a traditional double-reeved unit.



BENEFITS & FEATURES

Less Maintenance & Easier Inspection

- Brake location allows for quick access and easy inspection.
- Lifetime grease-lubricated Gear Box means no oil change is required.
- Clutch located outside the Gear Box allows for easy access, which eliminates the need for complete disassembly and reduces downtime.

Improved serviceability

Easy access to the Clutch, Motor, Electrical Control Panel and Brake Assembly.

Longer Service Life

- Heavy-duty DC brake is designed for a long service life.
- Lifetime grease-lubricated Gear Box and helical gearing ensure better wear and smooth operation. Heavy-duty rated motors.

Improved Load Safety

Clutch is located outside the load path preventing slipping of the load in an overload condition when the brake is not powered.

Improved chain life

5-Pocket Lift Wheel provides better chain and lift wheel engagement for smoother lifting and reduced vibration equating to less wear and a longer chain life. Zinc plating protects chain from environmental conditions.

EASY ACCESS CONTROL PANEL

Finger-safe wiring and plug-and-play connectors on the Control Panel allow for quick voltage change, easy access to terminal strips and simple fuse installation.

ZINC PLATED Load Chain

Designed and manufactured by Columbus McKinnon. 10 millimeter, zinc-plated Star Grade load chain protects against corrosion. Meets EN 818.7 Standards.

ADJUSTABLE LIMIT SWITCH

Easy-to-adjust screw limit switch automatically stops the hook at any predetermined point when either lifting or lowering, preventing overtravel.

OVERLOAD PROTECTOR

Helps prevent lifting of dangerous overloads.

METRIC RATED LIFETIME WARRANTY

The industry's best warranty against manufacturing and material defects.

STANDARD ROTATABLE LIMIT SWITCH

Designed for quick reset of limit position.

SWIVEL OR RIGID HOOK SUSPENSION AVAILABLE

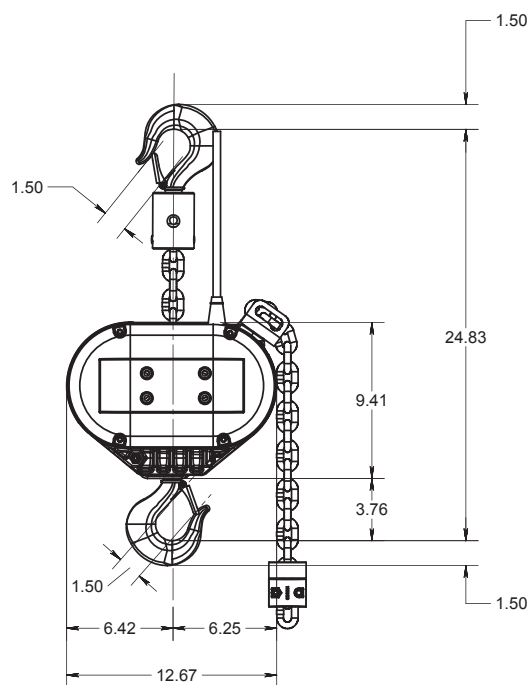
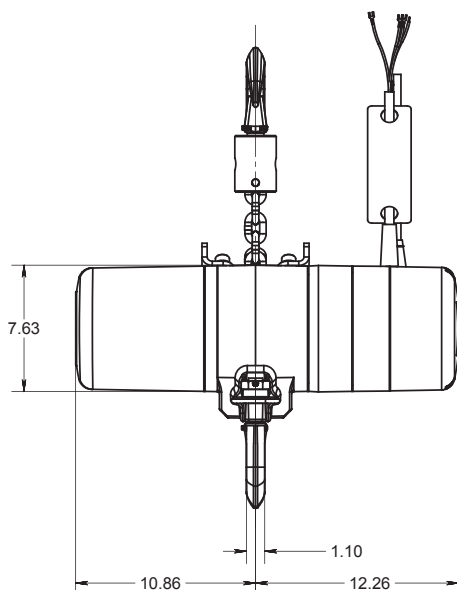

OPTIONAL FEATURES

DOUBLE DC BRAKE

Two independent acting DC brakes for redundant braking. Field installation kit available.

DOUBLE LIMIT SWITCH

Adjustable screw limit switch that will automatically stop the hook at any predetermined point when either hoisting or lifting.

Encoders

Available for positioning incremental and absolute.

VARIABLE SPEED UNITS AVAILABLE (VFD)

Varistar or variable speed versions available. Please contact your CM-ET sales representative for details.

CM Alloy Latchlok® hooks

Latchlok® hooks combine innovative design and solid alloy steel. I-beam construction offers more reliable performance than any other hook on the market.

- One-hand operation and recessed push-button thumb release for smooth and dependable opening.
- Hook remains locked until released by the operator, even if chain goes slack.
- Sturdy forged heat treated I-beam construction for strong, yet lightweight hooks.
- Lifetime warranty.
- Made in U.S.A.

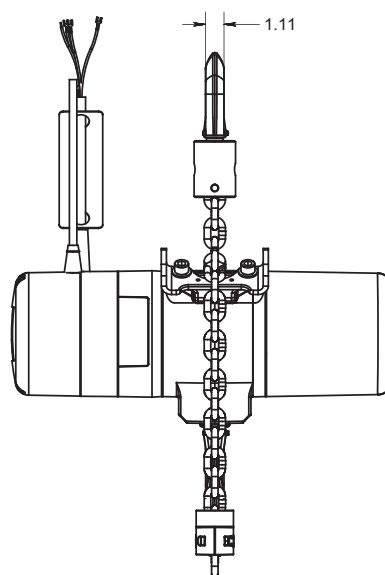

DIRECT CONTROL UNITS

The CM Lodestar is available as a Direct Control Unit. Featuring a single cable, this Direct Control Unit can be used as part of a system with multiple units with a single control. The Lodestar is compatible with most Direct Control Motor Controllers.

D8+

Meets all Standard VPLT SR 2.0/SQP2 requirements.

BGV-C1

Meets all standard C1 and DIN 56950 requirements.

EXE

TECHNOLOGY

Products within the EXE range have been engineered to safely move and position stage equipment, scenery, video walls & other related structures before, during and after your performance.

EXE

RISE

CHAIN HOISTS

Every single component of the EXE Rise chain hoist main body is manufactured in Italy.



EXE

DST

DYNAMIC STACK TRACKS

Multi-purpose built-in rail systems with modules that move LED screens, scenery and lights. They are easily used since they are modular and stackable for storage. Two models are available, the 52 version for heavy duty applications and the 40 version for small-medium sized projects.



EXE

DRIVE

CONTROLLERS

The range features 4 and 8 Channel Base controllers in 3U and 5U rack mountable chassis, 4 and 8 Channel Digital Link controllers, both in 5U rack mountable chassis and their complementary accessories.



EXE

CELL

LOAD CELL INTERFACE

The EXE RISE LOAD CELL INTERFACE system works as standalone load cell reader, fully integrated in a chain hoist body to give riggers the possibility to see, in real time, the individual weight applied to the chain hoist during all rigging operations.



EXE
CELL

LOAD CELL INTERFACE PRO



THE FIRST FULLY INTEGRATED LOAD CELL INTERFACE

The system works as a standalone load cell reader, fully integrated in an EXE RISE chain hoist body to give riggers the possibility to see, in real time, the individual weight applied to the chain hoist during all rigging operations.

It is built around a self-powered electronic circuit board equipped with an LED display, built into a metal cover that can replace the standard end cover of the hoist. The circuit board is connected to a special body hook with integrated load cell reading system.

The electronics are designed to withstand shock loading typical within the environment where the products are used, and can handle working temperatures from 14 to 140° F with humidity up to 90%.



FOR MORE INFORMATION PLEASE VISIT WWW.EXETECHNOLOGY.COM

HOIST CONTROLLER SKJONBERG

CS-400R

30 amp main input 3 phase 1hp motor at 208v - 240v



1) 4 channel power and control unit is portable and compact

2) Rack back

3) Safety key switch for on/off and phase selection



Power control
Various cable lengths



Detachable cable
Custom unit available for single phase motors

CS-800

50 amp main input 3ph
1hp motor at 208v - 240v

Optional road case



TWO STYLES OF CONTROL PENDANTS



Square



Rectangle

OPTIONAL DETACHABLE CABLE



RC

HOIST CONTROLLER SKJONBERG



POWER DISTRIBUTION SYSTEMS

Safe and reliable power is a must to ensure that events go off without a hitch. Our systems come with a diverse array of connector and breaker arrangements, and can be configured for 110V single-phase, 125/250V, 120/208V three-phase Y, and 208V three-phase power. Whether you need to power lighting, amplifiers, backline, or accessories, we have the right solution for you.



HOIST CONTROL SYSTEMS

Chain hoist control is a precise business, and lifting tons of gear above a stage requires skill and planning. Our hoist control systems ensure safe and reliable solutions that work with all industry standard chain hoists, and incorporate electrical phase reversing for extra convenience.



CELL*MATE WEIGHT MONITORING SYSTEM

Use our Cell*Mate weight monitoring system to simultaneously watch critical loads from one or more remote locations. Using state-of-the-art stainless steel load cells to measure tension on your rigging points, cells are rated for either 2 ton or 5 ton loads and work in unison with our Cell*Mate Hub and Digital Display Modules.



CABLE ASSEMBLIES

We have connections for every product we make and are made of the highest quality materials. Our advanced production techniques enable us to build Cable Assemblies efficiently and cost-effectively.



THE SERVER - ADVANCED RIGGING INTELLIGENCE

Design dynamic productions with the easy-to-use and portable SERVER System, an advanced hardware/software solution that monitors the exact position of every hoist in a grid. Easily create groups of hoists that move together with one-click automated sequencing by setting the thresholds and watch the entire grid move safely into place.



SATELLITE POWER DISTRIBUTION PRODUCTS

Our RacPacs and Stringers are designed with utmost flexibility to deliver power where you need it – for your amp rack, dimmers, or just a rack full of gear. If your truss or backline needs power, we have a variety of Stringer boxes to match your needs.

Crowd Barriers

James Thomas Engineering Crowd Barriers offer high quality craftsmanship and design at competitive prices.



Crowd Barriers

JTE modular crowd barrier system. Designed with both sides of the barrier in mind.



PEOPLE ARE THE LIFEBLOOD OF THE ENTERTAINMENT BUSINESS.

The more people that come to your event, the happier you are, and the more successful your event will be. But when you have a larger amount of attendees, you have an increased need for tools that help you organize, segregate, block and contain.

Enter the JTE modular crowd barrier system.

JTE has a large array of barriers that have been designed with both you and event attendees in mind. JTE knows that people on both sides of the barrier must be offered comfort, convenience, safety and security.

ADVANTAGES FOR EVENT ORGANIZERS:

- Made from rust-free aluminum
- Extremely durable for many years of trouble-free use
- Light weight for quick set-up and break down
- Hand cut-outs for easy and convenient manipulation
- Foldable design for compact storage and reduced transport size
- No sharp edges for the safety of security personnel, as well as for safe set-up and break down
- Clean and professional look
- Available in a wide variety of colors
- Custom barrier designs on request

ADVANTAGES FOR EVENT ATTENDEES:

- Perforated plate so fingers and jewelry don't get caught
- No sharp edges
- Flexible corners on some barrier products for increased safety during crowd pushing



Crowd Barrier - Standard Module

TC CWB-B

They are standard lightweight crowd control systems. They can be bolted together for one firmly anchored fence that will remain in place even in very agitated situations. They fold flat after use and can be stacked on dollies or easy transport and storage.

Material	Dimensions	WT lbs
Aluminum alloy EN AW-6082 T6	40.74 x 49.21 x 46.65 (H) inch	88.85

Connection kit included



Crowd Barrier - Adjustable Corner Module

TC CWB-VC

Apart from the standard section, the barrier can be delivered in several corner types to meet any environment requirements. It folds flat after use and can be stacked on dollies for easy transport and storage.

Material	Dimensions	WT lbs
Aluminum alloy EN AW-6082 T6	40.74 x 49.21 x 46.65 (H) inch	105.82

Connection kit included



Crowd Barrier - Standard Half Module

TC CWB-BH

Foldable, all aluminium barrier that's half the size of a standard barrier. Bolts together with single modules for a unified, firmly anchored barrier that withstands unruly crowds. Fold flat after use and stack on dollies for convenient transport and storage

Material	Dimensions	WT lbs
Aluminum alloy EN AW-6082 T6	20.39 x 49.21 x 46.65 (H) inch	45.85

Connection kit included



Crowd Barrier - Gate Access & Cable Slot Module

TC CWB-DC

Crowd barriers are used ad hoc when audiences and spectators need to be held at a distance, but sometimes you need to have an easy access. This is the case with this variant provided with a gate. Crowd barriers ensure safety, high quality and ease of use with ergonomics and easy handling. They fold flat after use and can be stacked on dollies for easy transport and storage

Material	Dimensions	WT lbs
Aluminum alloy EN AW-6082 T6	40.74 x 49.21 x 46.65 (H) inch	99.20

Connection kit included



Crowd Barrier – Cable Access Module

TC CWB-BC

Crowd barriers are used at sports events, political rallies, parades, demonstrations, and outdoor and indoor performances. This model can hold cables for a safe way of laying and protecting cables, hoses and ducts. All profiles have soft, rounded edges for maximum comfort. They fold flat after use and can be stacked on dollies for easy transport and storage

Material	Dimensions	WT lbs
Aluminum alloy EN AW-6082 T6	40.74 x 49.21 x 46.65 (H) inch	108,68

Connection kit included



Crowd Barrier - Trolley Module

TC CWB-V-CART

A quality aluminum trolley has been developed to hold 10 folded standard crowd barriers. Crowd barriers folded flat are easily stored and transported in the trolley.

Material	Dimensions	WT lbs
Aluminum alloy EN AW-6082 T6	53.54 x 45.47 x 50.08 inch	130.07



Crowd Barrier – Vario Light Module

TC CWB-VL

A double-hinged corner without floorplate, the Vario Light module is a vertical part that connects with other barriers sections. This enables the Vario Light module to angle in any shape wanted varying from -90° to +90°.

Material	Dimensions	WT lbs
Aluminum alloy EN AW-6082 T6	41.53 x 45.07 inch	44.09

Connection kit included



Crowd Barrier – Vario Light With 15 cm Module

TC CWB-VLC

A double-hinged corner without floorplate, the Vario Light module is a vertical part that connects with other barriers sections. Barrier module with 15 cm cable slot. 0° to 90°

Material	Dimensions	WT lbs
Aluminum alloy EN AW-6082 T6	36.30 x 8.84 x 46.70 inch	42,10

Connection kit included



Crowd Barrier - Outside Corner 90° Module

TC CWB-OC90

Barrier module for cretaing 90° outside corners. Bolts together with single modules for a unified, firmly anchored barrier that withstands unruly crowds. Fold flat after use and stack on dollies for convenient transport and storage

Material	Dimensions	WT lbs
Aluminum alloy EN AW-6082 T6	38.11 x 70.00 x 46.69 inch	67.02

Connection kit included



Crowd Barrier - Inside Corner 30° Module

TC CWB-IC30

Barrier module for cretaing 30° inside corners. Bolts together with single modules for a unified, firmly anchored barrier that withstands unruly crowds. Fold flat after use and stack on dollies for convenient transport and storage.

Material	Dimensions	WT lbs
Aluminum alloy EN AW-6082 T6	27,01 x 49.21 x 46,69 inch	34,83

Connection kit included



Crowd Barrier - Inside Corner 90° Module

TC CWB-IC90

Barrier module for cretaing 90° inside corners. Bolts together with single modules for a unified, firmly anchored barrier that withstands unruly crowds. Fold flat after use and stack on dollies for convenient transport and storage.

Material	Dimensions	WT lbs
Aluminum alloy EN AW-6082 T6	30.80 x 69.88 x 46,69 inch	60.62

Connection kit included



Crowd Barrier - Single Gate Access Module

TC CWB-SGA

The single gate barrier module is the right choice when you need only one access point for crowds entering live events. Bolts together with single modules for a unified, firmly anchored barrier. Fold flat after use and stack on dollies for convenient transport and storage.

Material	Dimensions	WT lbs
Aluminum alloy EN AW-6082 T6	52.08 x 43.30 x 46.69 (H) inch	126.97

Connection kit included

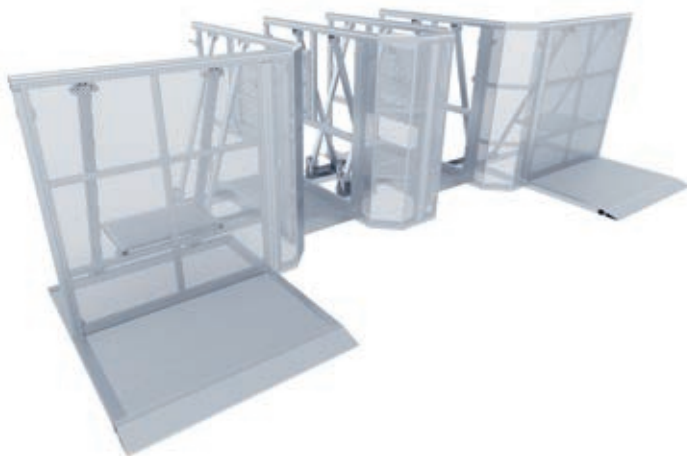

Crowd Barrier - Two Entrance Checkpoint

(2)TC CWB-B; (4)TC CWB-90C; (2)TC CWB-SGA

A safe and secure check point with two entry points. Easy to move, store, transport, install and disassemble. All aluminium construction offers you extreme durability during all seasons, as well resistance to aging and corrosion.

Material
Aluminum alloy EN AW-6082 T6

Connection kit included



Crowd Barrier - 90° Compensator

TC CWB-90C

The compensator serves as a standing area between the two entry points of the Two entrance check point and to connect the entry point to the standard barrier.

Material	Dimensions	WT lbs
Aluminum alloy EN AW-6082 T6	16.73 x 5.55 x 46.69 (H) inch	17.86

Connection kit included



Crowd Barrier - Emergency Gate Module

TC CWB-EG

Emergency Gate Module provides immediate access to your audience when it counts the most. Footsteps above the deck allow for easier lifting of persons with health issue over the barrier and two separate door gates provide a convenient 115 cm entrance/exit point for your staff before, during and after the event.

Material	Dimensions	WT lbs
Aluminum alloy EN AW-6082 T6	81.50 x 49.21 x 46.69 (H) inch	222.27

Connection kit included



Crowd Barrier - Height Adjustable Adaptor

TC CWB-LHA

height adjustable adapter ensures that your barrier modules are stable and secure on uneven ground and other types of challenging terrain.

Material	WT lbs
Aluminum alloy EN AW-6082 T6	9.48





Custom Projects



SOUTH BEND RIVER LIGHTS BY ROB SHAKESPEARE

Color splashes from two interactive light sculptures - Trio and Forest on either side of the river, amplifying the majestic cascade of water, joined with a third sculpture named Disuvero, highlighting the exquisite "Keeper of the Fire" statue, and symbolically uniting the two sides of the river. Located in the heart of South Bend, near Seitz Park and the Century Center Island, the display serves as an economic development engine, a source of community advancement, a tool for visitor attraction, and a destination for recreational, artistic, and entertainment delight. The lighting pieces are designed to be interactive, and thematically colored to correspond with holidays and events. It will be the only display of its kind in the entire world. The entire concept was created and executed by artist Rob Shakespeare.

SEE MORE AT: [HTTPS://DOWNTOWNSOUTHBEND.COM/RIVER-LIGHTS](https://downtownsouthbend.com/river-lights)





A photograph of the Indiana University Art Museum at dusk. The building is a large, modern structure with a prominent vertical section illuminated in a warm, reddish-orange glow. In the foreground, a tall, slender, lattice-structured tower, the 'Light Totem', stands illuminated with vibrant green and blue lights. To the right of the tower is a large, circular, red sculpture with a central opening, set on a grassy lawn. A paved walkway leads from the bottom left towards the center. The sky is a deep, clear blue.

INDIANA UNIVERSITY ART MUSEUM (LIGHT TOTEM)

James Thomas Engineering was proud to partner with Rob Shakespeare to create Indiana University's iconic "Light Totem" sculpture outside of the IU Art Museum. Light Totem is a single tower permanently standing over 70 ft high. The sculpture and the soothing color changing LEDs can be experienced every night and it has become a large part of the University and the community.



JTE SUPPORTS MARVEL UNIVERSE LIVE!

Two of the biggest names world-wide in truss systems and equipment, TOMCAT and James Thomas Engineering, have done it again. This time with one of 2015th largest touring productions, Marvel Universe LIVE!





TEMPORARY STRUCTURE IN FLORIDA

The James Thomas Engineering PLBR in Florida is one of the many temporary roof structures located in theme parks all over the United States. This system contains Super Pre-Rigged Truss, 20.5" Folding Triangle, 20.5" SuperTower, a custom center corner block, standard pivot sections, and 12" and 20.5" General Purpose Truss. With so many products in one system, this system is a fine display of James Thomas Engineering products in action.



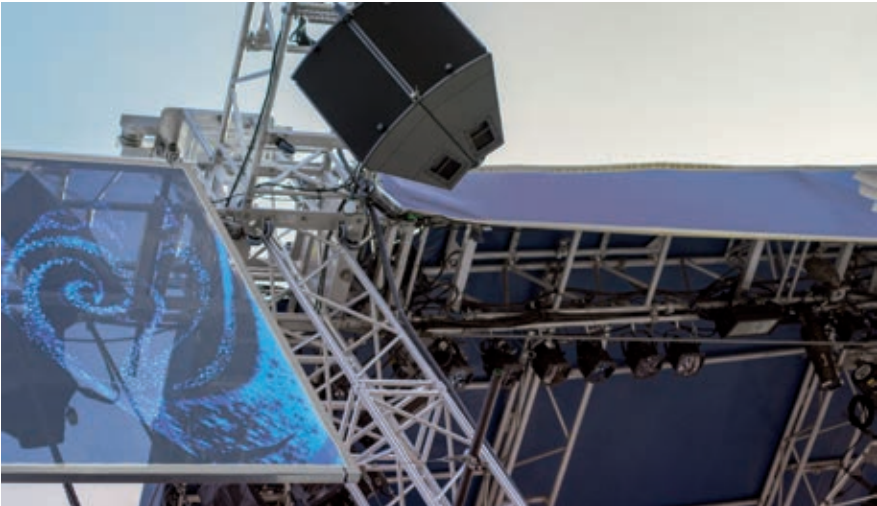

RADIO CITY MUSIC HALL NEW YORK

Along with Pook Diemont & Ohl, Inc., James Thomas Engineering customized over 500 feet of 12" x 18" SuperTruss to create a working platform above one of the most historical and well-known stages in the United States. This system replaced the theaters original wooden beams and ropes that were used until 2012.



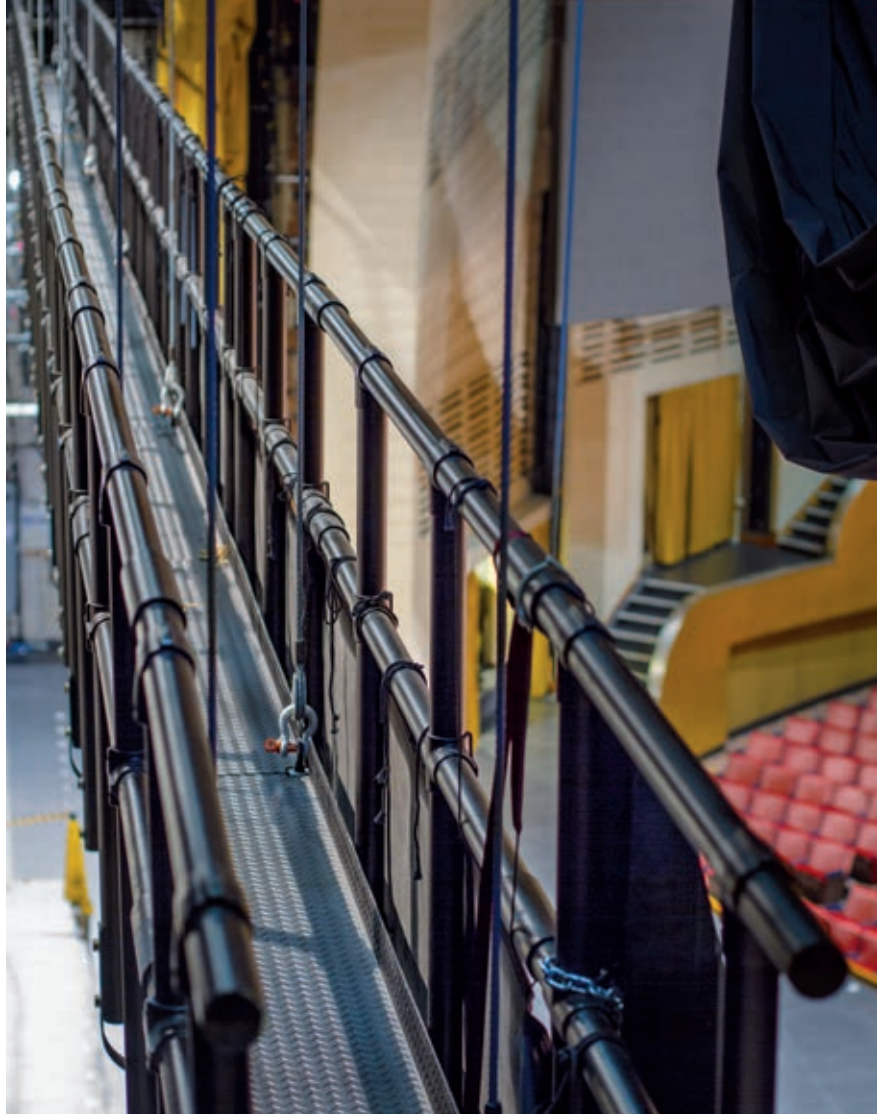

DENTS, BENDS, ABRASIONS AND TWISTS

CONSIDERATIONS FOR TRUSS INSPECTION

Safety is a huge concern for the live event production industry. The following information focuses on a critical component: Inspecting truss and referencing ANSI E1.2-2012 Entertainment Technology — Design, manufacture and use of aluminum trusses and towers.

CHECKING GEOMETRY

Your first clue that a section of truss might have a geometry problem would be if it doesn't sit flat on a flat surface. To investigate further, place two or three flat bars on the top of the truss section. If they don't line up, it's likely that the truss has been racked in the center. If there is a successive dip from bar to bar, then the truss is showing signs of a twist. Any time that these three alignment bars don't align, you have cause for concern.

You can also measure the truss diagonally in all faces, comparing the distance from the upper left corner to lower right corner with the distance from the upper right corner to the lower left corner. A good tolerance range on this diagonal measurement would be 1/16 inch. You should contact the manufacturer if you find any more than that.

INSPECTING TRUSS MEMBERS

Dents, bends and abrasions can happen to any of the members. This is usually due to poor handling, but can also be caused by using the wrong type of clamps, the chain rubbing against the truss, or any variety of other occurrences. A good rule of thumb to determine excessive damage is the 25 percent rule. If any abrasion, bend or dent is deeper than 25 percent of the wall thickness of the material, then the truss needs to be removed from service.

Keep in mind that most members in typical bolted truss are only 1/8 inch thick. So dents, bends and abrasions that are only 1/32 inch deep would fall into this category.

Any damage to the chords are of particularly high concern. They effectively transfer the load down the length of the truss section. Furthermore, since there are so many other members welded to them, it is not reasonable to repair or replace them.

CHECKING WELDS

There are a couple of types of weld cracks that you might find when inspecting truss. The first is what you could call a "hairline" crack. Found in the final tie-in of the weld, these are typically surface cracks and usually run perpendicular to the weld bead around the member. The second type of weld crack would be a "stress" crack. A stress crack typically runs parallel to the weld bead. These are of great concern since they're an indication of excessive stress on the truss, or at least on that member. With all cracks, make sure you consult the manufacturer for advice.

Since aluminum truss is fabricated using tempered material, adding excessive heat to it, like welding, changes the properties of the material. This creates a heat affected zone (HAZ) around the weld. It is in this area that you would be more likely to see a sign of failure, as it is much weaker than raw, un-welded material.

CHECKING CONNECTIONS

Next, check the connections. Many people forget to inspect the hardware when inspecting truss, but the pins and bolts are just as relevant as anything else.

First, ensure that graded hardware matches. If you are using Grade 8 bolts, you need to have Grade 8 nuts. Next, make sure there isn't excessive wear on the fasteners.

Next, check fasteners for deformation. This applies to both the hardware and the connection device itself. Deformation in the hardware is pretty straightforward. You want threads on bolts to be clean, and the pins in spigoted or other pinned truss to be straight and the proper diameter. A bent or bowed pin is a sure sign of overstress.

Deformation in bolted truss plates can take two forms. You need to inspect for both. First would be the holes themselves. They need to have the appropriate roundness. If they are oval-shaped, there is a problem. Second is the flatness of the plates. When bolted truss is overstressed, the plates can potentially bow or stretch outward. Once this happens, they will not return to their original shape. This makes the truss dangerous.

Spigoted truss is a little different, but you are looking for similar evidence. First, the holes need to be the proper shape. Once again, they need to maintain their original shape. If you are using spigot or fork connections, make sure that the blades are straight.

With spigot-type connections, you also have to look at how the connection is installed in the truss. If they are welded, you should have already inspected them, but again review for cracks. If they are mechanically fastened with roll pins, you need to check if the connection is loose. Inspect the rollpins as well. They should be flush on both sides of the tubes, and the holes they are in should be tight all the way around. If you see a gap between the back of the roll pin and the material it is mounted into, this is a sign that the truss has seen excessive loads and needs to be removed from service.

“FREQUENT” VS. “PERIODIC”

The ANSI standard notes two types of inspections: “frequent” and “periodic.” Frequent inspections are to be conducted every time a truss is used. Before you start rolling your eyes, first consider that you are hanging stuff overhead, but second, consider how long it really takes to do a visual inspection of the truss.

This can be done with the truss coming off the truck during load-in. Specifically, the standard calls for the person doing the inspection to be a “competent” person, who is, and I am paraphrasing, someone who is capable of identifying hazards and authorized to take action. So, presumably, someone who is responsible for hanging equipment overhead would also be someone that is competent to conduct these visual truss inspections.

**HERE IS A LIST OF THE ITEMS
THAT MUST BE INSPECTED,
AS PER ANSI E1.2-2012:**

Geometry of trusses and towers for:

Twisting of the truss or tower
Racking of the truss or tower
Bending of the truss or tower

Chords for:

Dents
Bends
Abrasions

Diagonals for:

Dents
Bends
Abrasions
Being Missing

Connecting plates for:

Flatness
Deformation or excessive wear of holes

Pinned connector forks for:

Deformation

Fasteners for:

Proper Grade - Must Be Matched
Deformation
Excessive Wear

Welds for:

Breaks, Cracks, or Deformation
by visual inspection

The second type of inspection is a periodic inspection. This inspection is one that requires records to be kept. You should start keeping records of each section of truss when it is first acquired, and then every year thereafter. The records should indicate the date of inspection, and who performed the inspection. As opposed to the competent person for frequent inspection, the periodic inspection requires a “qualified” person. This is defined as someone that has either through a degree, certificate or extensive experience, demonstrated the ability to solve problems related to truss.

Along with a commitment to inspections, the record-keeping aspect of truss inspection is important. When an investigation begins, a request for inspection records will be one of the first things to come up.

A last word of caution. Truss has long been considered an afterthought, or less important, than the lights, audio or whatever else. But considering that it is a key element to holding all of that equipment in the air, it definitely needs the appropriate attention and respect to ensure safety for the performers, technicians and audience. Be safe out there.



TRUSS USE GUIDELINES

HANDLING

James Thomas Engineering Truss is engineered to provide many years of dependable service, provided that it is handled properly and used within the recommended loading parameters.

Do not drag or drop truss, as this may damage the ends of the truss or result in other unseen damage. The ends of the tubes need to be maintained as round as possible so that connections will be complete.

When transporting, take steps to ensure that nothing rubs against the truss that might cause wear or punctures. When transporting vertically, truss with spigots should be arranged with the male members. When stacking truss for transport, secure the truss to prevent bouncing and do not load other items on top of the truss that could bounce and cause damage.

When loading, unloading, or moving truss, do so with enough personnel as to ensure that the truss is not dropped or dragged over other truss. This also ensures personal safety. Use forklifts with extreme caution! Place forks only under the bottom chord, as placing forks through the truss could damage diagonals. When storing truss always use protection on forked truss.

ASSEMBLY & USE

James Thomas box truss is typically designed with horizontal cross members on two opposing faces with diagonal members on the other two faces. The point in which two diagonals meet is called a panel point. The faces with horizontal cross members make up the top and bottom of the truss, while the faces with diagonals are the sides. (See Figure 1). Load data is only valid when the truss is oriented in this fashion. Load data is only to be considered for indoor use. Load data takes into consideration the self-weight of the truss and indicates how much additional weight may be safely added.

TRIANGLE truss should be oriented with the apex up. Turning it over reduces load capacity significantly. For folding-triangle truss, the apex is the hinged pair of chords. When connecting sections of truss, make sure the diagonals form a continuous pattern. (See Figure 2.) The diagonals on each side of the connection should be opposed, not parallel. Span lengths and load specifications, as published by James Thomas Engineering, should not be exceeded without first contacting JTE/TOMCAT. The balance between members, and the even distribution of the load across the truss, is an important consideration, as unbalanced loads could twist the truss resulting in damage. For optimum weight distribution, it is recommended that the truss itself be hung using the lower chords, while additional loads be suspended from the upper chords. All loads should be applied at panel points as described above. Local bending of members may occur if loads are applied at locations other than panel points.

All truss connecting parts should be inspected regularly. When using nuts and bolts, each should be inspected on a regular basis. Use only grade 8 bolts and nuts. Thomas D-clipped washers should be used on both sides. Nuts and bolts should be replaced periodically as regular use degrades bolt threads. Never over-torque the nuts and bolts beyond manufacturer's specifications.

(72 FT/LBS for temporary structures and 125-130 FT/LBS for permanent structures)

Prior to lifting a truss, one person should be responsible for checking all truss connections and the rigging on the truss, ensuring that rigging has been done at the panel points. When raising truss, hoists should run simultaneously once the truss is leveled. Always observe the hoists closely when moving truss, and stop every 15 feet to check the level of the grid. This is particularly important if the grid is unevenly loaded. When disassembling truss, do not break any connections until there is no weight on the joints.

FIGURE 1.

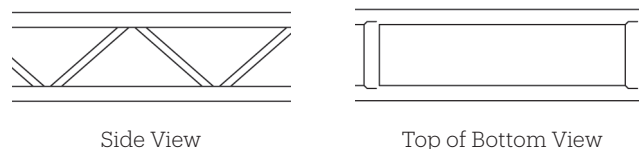
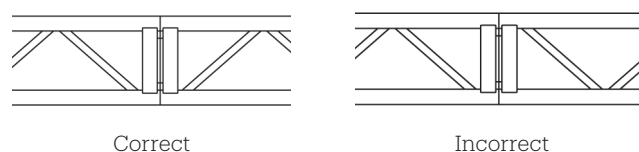

FIGURE 2.



TIPS FOR A SAFE OUTDOOR CONCERT SEASON

THE ANSI E1.21 - 2006 STANDARD REQUIRES AN OPERATIONS MANAGEMENT PLAN—A FULL RISK ASSESSMENT AND RISK MITIGATION TOOL FOR ALL PARTIES AT OUTDOOR EVENTS

We are currently leading up to another outdoor concert season, or recently completed one. Hopefully, you've already ensured, or successfully ended, the safest summer concert season possible.

Much attention has been focused on outdoor structures and with good reason. No one ever wants injuries, let alone fatalities, to occur at concerts or any other entertainment events. Recent incidents have prompted a number of questions, ranging from what guidelines exist for outdoor roof structures and events, to who is responsible for various aspects of these events.

Fortunately, published guidelines have been available to the US temporary outdoor roof market since 2006: ANSI E1.21-2006. This standard provides minimum guidelines for these structures and is an important reference for anyone involved in these types

of events. We must add that this document should not be limited to people who design, manufacture, and set up these structures; those who hire or perform under these structures should be aware of it, too.

However, the next 1,500 or so words will focus on stakeholders who own, maintain, and operate these structures. Many other stakeholders should depend on the expertise of this group to provide guidance and make decisions, so it is imperative that owner/operators have a thorough grasp of the realities of these structures.

In the age of the 24/7 news cycle, with its constant stream of information and misinformation, the discussion of sensitive issues can be marred by fact-free speculation and a rush to judgment. Some statements are based on minimal information; others are



outright false. After 2011's tragic stage collapse at the Indiana State Fair, even entertainment industry blogs and forums spread incorrect information. Many so-called "experts" made it clear, by virtue of their comments, that they were out of their depth. To dispel some of these myths, let's start with what comprises a proper temporary outdoor structure that complies with ANSI E1.21 - 2013. One of the lengthiest and most critical sections in E1.21 - 2013 deals with design and engineering. In brief, it says that for any structure to comply, it must be designed in accordance with accepted engineering practice as a purpose-built structure.

There seems to be common misconceptions about this requirement. Many outdoor structures in the marketplace use multi-purpose components. For example, the lifting mechanism may be a chain hoist frequently used for an indoor event, or some of the structural framework of the structure itself may be aluminum truss that is also regularly used indoors. Regardless of the other uses of these components, if their specific capability within the context of the "system" has been considered by the design professional and is found to be sufficient for the outdoor application, then they can be used for this purpose without question.

Many smaller or younger companies purchase various parts and components in phases, with the intent that they will ultimately be able to assemble all of these pieces into a complete structure. This is an acceptable way to proceed if, and only if, the engineering analysis of the structure is also a part of the process. In other words, just because you see an erected structure in use doesn't mean you can simply buy what you think are all of the exact components you have seen, and voila, you are in the roof business. The components in some structures may have the appearance of common items, but could indeed be fabricated or assembled differently in order to accommodate changes in how they must perform in the context of a compliant outdoor structure. What is key is that the structure must be designed as a complete system, not simply as a grocery list of parts.

The ANSI standard does not dictate which materials can or cannot be used. This is an important point, because there are different ways to accomplish different things. It wouldn't be appropriate, even for a voluntary standard such as this, to dictate methods and materials, or even eliminate the possibility of building a better mousetrap. What it does dictate, however, is that the structure must comply with the prevailing engineering methods and practices, basically using the same laws of physics that we all have to deal with here on the third rock. For owner/operators, this engineering analysis must be documented and in your possession. Regardless of whether you get it from the manufacturer, the previous owner of your structure, or an independent engineer of your choosing, it is your responsibility to keep copies of the drawings, calculations, operating limits, and set-up requirements. These documents have long been required by various municipalities, many of those authorities might also require event permits or local oversight. Certainly, in light of recent catastrophes, the focus is going to increase exponentially on having this documentation.

This point can't be overstated. It is paramount to ensure that the erected structure, loads and operating limits match these documents. Just because you might have a package of engineering calculations, with drawings and some text, doesn't mean you have fulfilled the requirements. You must be able to demonstrate with each and every use that what is physically setup is compliant with that big package of documents. The requests for this package of information are going to be coming from multiple directions, so be prepared for it.

The Event Safety Alliance (www.eventsafetyalliance.org) has established contract language related to outdoor structures that specifically identifies compliance with ANSI E1.21-2013. This language has been adopted by some major artists and events for inclusion in their performance contracts. This means that promoters, or anyone hiring these artists, must comply with this language. Knowing that this all rolls downhill, we can expect that if the artist requires it, the promoter or venue will require it. And this is separate from the local authority having jurisdiction (building official) requiring or requesting this documentation. So, if you have a structure that you intend to use outdoors, and you DON'T have engineering documentation, you need professional engineering assistance right away.



PLBR
Busch Gardens

PLBR Roof System
with Sound Wings



WHAT IS KEY IS THAT THE STRUCTURE MUST BE DESIGNED AS A COMPLETE SYSTEM, NOT SIMPLY AS A GROCERY LIST OF PARTS.

The next important aspect, and one of the first things that investigators ask for, is inspection records. Once again, the ANSI standard outlines some minimum requirements for inspections, along with which records need to be documented and their frequency. Basically, the components of the structures shall be visually inspected for every single use. The record-keeping process for each component must take place annually, at a minimum, with the component being out of service; it doesn't do any good to inspect something for damage when it is 50' above the stage. The intent is that you must demonstrate you are taking the appropriate measures to ensure that all of

the components you are using are in the correct condition, in addition to the first requirement mentioned above of having engineering documents identifying what components to use. This record-keeping process will mean that you have unique identification for each component (i.e. serial numbers), and specific dates correlating to each inspection. If you don't have these records on hand for your structure right now, immediately take the time to get each component inspected. The manufacturer of your components should be able to provide you with inspection guidelines if needed, so do not hesitate to contact them.

YOU MUST BE ABLE TO DEMONSTRATE WITH EACH AND EVERY USE THAT WHAT IS PHYSICALLY SET UP IS COMPLIANT WITH THAT BIG PACKAGE OF DOCUMENTS.

Lastly, and arguably the most important aspect of outdoor roof structures, is how they are managed during events. The ANSI standard identifies a requirement for an Operations Management Plan (OMP). This plan, which is to be developed with input from the designer and manufacturer, must be a full risk assessment and risk mitigation tool. The OMP is meant to identify what action must take place with the structure in the event that various foreseeable events occur. These could include anything from the issuance of local weather alerts, to certain amounts of rain falling, to specific wind thresholds being reached on the site. Of course, weather is likely the biggest variable for outdoor shows and it is important to be very clear about what action you will take when unfavorable weather occurs. Some of the TOMCAT team recently attended a seminar at the National Weather Center in Norman, OK. Aside from meteorologists' extreme dislike for being mocked about their perceived lack of forecasting skills, it was quickly reinforced that weather is unpredictable even with the most state-of-the-art technology. It was clear to us, however, that one of the most fundamental things we took away from this event is that much of the available weather information we receive from local news or websites is not specific enough to be used for decision-making.

For example, most weather forecasts do not include information about wind forces that may be coming in front of a storm. It is possible that extraordinary wind could be as much as 10 miles ahead of a storm front, but the available radar images might not pick that up. Additionally, the radar images that you have access to may be out of date. Sometimes, even a few minutes makes a big difference with evacuation or other preventative safety measures. On top of that, radar technology may not provide a wholly accurate picture of what is approaching due to the proximity of the storm to the radar itself.

If all of this sounds discouraging, there is a better option. There are a multitude of reputable private weather services available. These services can be dedicated to your event so that you have a person that is monitoring your exact location and is in constant contact with you. Of course, this is an expense, but it can be far less expensive than going without the service, considering the destructive capabilities of weather.

Another portion of the OMP needs to be training and understanding of the actions in various conditions for all the people involved with the structure. These can include the promoter, artist, venue staff, security personnel, EMS, and local authorities. It doesn't do any good to have an action plan if no one knows what it is, or if everyone involved has his own plan and they don't work together. The language from the Event Safety Alliance includes requirements for having an event suspension and cancellation procedure in place. These can prevent the ugly argument from happening when everyone's emotions and adrenaline are preventing rational thought.

We would hope that if you are an owner/operator of an outdoor roof structure, everything here is simply a gentle reminder of what you are already doing. There are certainly risks with these structures that we would never be able to fully eliminate, but if we all take the appropriate precautions and plan accordingly, we can do our best to keep ourselves and all of the artists and concertgoers safe at our next event.



20.5 SuperTruss Ladder and Custom Tower Posts
Denver International Airport



**James Thomas
Engineering**

James Thomas Engineering

North America, South America, Asia, Australia

**5427 N National Dr.
Knoxville, TN 37914
USA**

**950 Lawrence Dr., Suite B
Thousand Oaks, CA 91320
USA**

**T +1 (865) 219 3700
salesus@jthomaseng.com
www.jthomaseng.com**

